

# **PULSAFEEDER**<sup>®</sup>

## Metering Pumps and Control Systems



**Product**

Effective 01/01/19

## TABLE OF CONTENTS

<b>Important Information When Placing An Order</b>	<b>3</b>
Feature Selection Guide	4
Model Selection Guide	5-9
<b>PULSAtron - Electronic Metering Pumps</b>	
Series MP	10-11
Series E Plus	12-13
Series HV	14-15
Series E	16-17
Series E-DC	18-19
Series A Plus	20-21
Series T7	22-23
Series C Plus	24-25
Series C	26-27
<b>Electronic Metering Pump Accessories</b>	
KOPkits	28-30
Kits	31
Parts	32-33
<b>BLACKLINE - Mechanical Diaphragm Pumps</b>	
Model Selection	34-35
Accessories and KOPkits	36
<b>Chem-Tech Pumps – Peristaltic Metering Pumps</b>	
Series XP	37
Series XPV	38
Series XP and XPV Parts	39
<b>Chem-Tech Pumps – Mechanical Diaphragm Pumps</b>	
Prime Performance	40
Series 100, 150 and Parts	41-43
Series 250 Parts	44
<b>Mec-O-Matic Pumps – Peristaltic Metering Pumps</b>	
Dolphin Series and Related Parts	45
VSP Series and Parts	46
2400T, 2400T Plus, and Parts	47
<b>Policies and Procedures</b>	<b>48-49</b>
<b>Terms and Conditions</b>	<b>50-51</b>

# IMPORTANT INFORMATION WHEN PLACING AN ORDER

1. Fax, mail or telephone orders directly to the Customer Service Department:  
 Pulsafeeder Incorporated  
 27101 Airport Road, Punta Gorda, Florida, USA 33982-2462  
 E-Mail: ppgpulsaspo.cs@idexcorp.com  
 Telephone: 800-333-6677 or 941-575-3800  
 Fax: 800-456-4085 or 941-575-4085  
 www.pulsatron.com
2. Please have the following information available when placing an order:
 

Account Name	Special Tags or Marks (if needed)
Billing Zip Code	Item(s) Being Ordered
Purchase Order Number	Quantity of Each Item
Ship to Address	Pricing
Payment Terms	Shipping Information
3. Orders are entered upon receipt. Our ability to change in house orders is limited. Please be certain your orders are complete when placed. Any order cancellation or change request is subject to a \$50.00 fee.
4. Orders are assigned standard lead times based on the size of the order and product mix.  
**Orders requiring expedited shipping (sooner than the standard lead times) may be subject to a \$50 expedite charge.**  
 Unless the order clearly requests expedited shipping, the order will be treated as a routine order. When expedited shipping is requested, a designated carrier must be selected. Orders that need to ship the same day must be received by **12:00 PM EST**. Same day and next working day shipping is generally available for larger orders, please verify with customer service. Pulsafeeder shall have no liability if it is unable to provide expedited shipping of an order.
5. Repairs and returns are coordinated through our Customer Service Department. All orders returned must have factory authorization, and are subject to a 25% restocking charge for standard product.
6. Orders can also be placed using PULSAshop, a secure webshop. Place orders where and when you want. Please register or log in at <https://pulsashop.pulsatron.com/pulsafeeder/login>.
7. Other Important Information:
  - Prices are subject to change without notice, and are effective when order is accepted, and acknowledged at point of shipment.
  - When ordering, specify your P.O. number, model number, quantity, price, shipping and/or billing address and order date.
  - **Standard terms are NET 30 days from date of invoice for approved accounts on open account.**
  - **WE ACCEPT VISA AND MASTERCARD.**
  - **ONE PERCENT DISCOUNT AVAILABLE FOR PAYMENT WITHIN 10 DAYS OF INVOICE DATE FOR ACCOUNTS THAT ARE CURRENT.**
  - **PAYMENT BY CREDIT CARD WILL NOT RECEIVE AN ADDITIONAL DISCOUNT.**
  - All prices are FCA, Shippers Dock, Punta Gorda, FL.
  - Custom product sales are final.
  - Charges for export documentation may apply. Fees vary by requirements.
  - Expedite fees may apply. **Orders requiring expedited shipping (sooner than the standard lead times) may be subject to an expedite charge**
  - **Minimum factory order of \$30.**
  - Fees for changes to or cancellation of orders may apply
  - Possession of price schedule does not guarantee right to purchase direct from factory.
  - Pulsafeeder has the right to ship any order when it is complete or partially complete unless the order is marked do not ship before the request date.

# PULSAtron® Feature Selection Guide

Pulsafeeder offers one of the most flexible electronic metering pumps in the world. The product can be configured to meet a large variety of applications and needs. The next few pages will guide you in structuring a complete and correct model number. The first step in selecting the right model for your application is to select the correct Series. Each Series offers a variety of features that distinguish it from other Series. Within each Series are selections of models that offer different flow/pressure envelopes to choose from.

The following descriptions will help you understand the different features and then the chart at the bottom of the page will let you select the appropriate models that have the features you need.

4-20mA	Control the pump stroke frequency based on a current input signal from an external device. At 4mA input, the pump will not stroke. At 20mA input, the pump will stroke 100%
20-4mA	Same as 4-20 except that at 20mA input, the pump will not stroke and at 4mA input, the pump strokes at 100%
External Pace / Water Meter	Allows the pump stroke to be controlled by an external dry contact closure, such as is provided by a Water Meter. For each closure, the pump will stroke one time. Some models provide the ability to multiply or divide the pulses.
Stop Function	A dry contact input that will stop the pump on closure and allow the pump to operate when open.
Touch Pad	Electronic 'touch pad' control with internationally recognized symbols.
Digital Display	Pump parameters are displayed on an LCD or LED type display.
Signal Relay	Provides a 24V DC signal output from the pump based on user specified conditions.
Power Relay	Provides AC power output from the pump based on user specified conditions.
Alarm Display	Flashing display or LED indicator that will display an alarm condition on the front panel of the pump.
Timed Sequences	Ability to pre-program operation for repetitive metering.
Programmable Timer	Timer that can be programmed with up to 8 on/off cycles per day during a 7-day week.
Hall Effect	Hall Effect Water Meter input.
Bleed Relay	Separate relay used to control a solenoid that will "Bleed" a cooling tower as part of a control system.
Timer Control	User defined timer functions that control when the pump will operate. Used in Cooling Tower control systems.
Flow Control	Optional Flow Switch turns pump on when flow is active.

Series	Flow Capacity		Pressure		Turn Down Ratio	4-20 mA	20-4 mA	External Pace And Stop Function	External Pace Or Stop Function	Touch Pad	Digital Display	Signal/Power Relay	Alarm Signals	Timed Sequences	Programmable Timer
	GPH	LPH	PSIG	BAR											
MP	0.13 to 21	0.50 to 79.5	20 to 300	1.3 to 21	1000:1	S	S	S		S	S	S	S	S	
E Plus	0.13 to 25	0.50 to 94.6	30 to 300	2.0 to 21	100:1	O		O							
HV	0.50 to 10	1.9 to 37.9	80 to 100	5.6 to 17	100:1	O									
E	0.21 to 1.85	0.80 to 7.0	100 to 250	7 to 17	100:1										
E-DC	0.25 to 1.85	0.90 to 7.0	100 to 150	7 to 10	100:1										
A Plus	0.25 to 2	0.90 to 7.6	50 to 250	3.3 to 17	100:1			O	O						
T7	0.50 to 2	1.9 to 7.6	100	7	10:1										S
C Plus	0.25 to 1.25	0.90 to 4.7	80	5.6	100:1				O						
C	0.25 to 1.25	0.90 to 4.7	80	5.6	10:1				O						

# PULSAtron® Model Selection Guide

Once you have selected the appropriate Series, you must configure the model so that it is built with the features you desire. The Configuration Guide associated with each Series will present the most popular selections. Select one code from each category to build up a complete model string.

To help you better understand the model string, in the following pages, we will explain what each of the digits represent and provide you some additional charts to help you select options not found in the Configuration Guides.

Series Code Designator	
Series MP	M
Series E Plus	P
Series HV	V
Series E	E
Series E-DC	S
Series A Plus	B
Series C Plus	D
Series C & T7	C

## Model Selection:

The first four digits represent the Series and Flow/Pressure Selection.

**LB02**  
 Series

The first digit will always start with the letter 'L'.

All PULSAtron models begin with this letter. The second letter designates the Series (e.g. Series MP, Series E+, Series A+, etc.). Each series has a different set of features that are available in terms of control and flow/pressure capacity. The next two digits represent the flow/pressure capacity of the pump.

**LB02**  
 Flow/Pressure Code

Digits 3 & 4 represent the Flow/Pressure Code.

This code represents the specific flow/pressure rating for the model and can be found in the specification for each Series.

**LB02SA**  
 Electrical Controls

Digits 5 & 6 represent the Controls and Electrical selections.

These selections are explained for each model in the Configuration Guide.

# PULSAtron® Selection Guide cont'd

## Selecting the Wet-End Code & Connection Type:

Digits 7-10 in the string represent the wet-end code. It is the group of four digits set apart by the dash lines.

# LB02SA-PTC1

These four digits represent your wet-end code and connection type.

The four digits in the wet-end code represent the Head Material, Seats & O-Rings, Ball Material and Connection type. Using the above example, the code breaks down as follows:

- P** - Head Material, including fittings. In this example, the P represents GFPPL.
- T** - Seat & O-Ring Material. In this example, the T represents TFE.
- C** - Types of Balls used in the valves. In this example, the C represents Ceramic.
- 1** - Connection type. In this example, the 1 represents tubing connections for 3/8" OD tubing.

In the configuration Guide, we have listed the most popular Wet-End codes. If you don't find the materials or connection selection to meet your needs, refer to the following selection guides to configure the proper Wet-End Code.

## Selecting the Wet-End Code:

The wet-end code represents the materials of construction that will be in contact with the chemical you are pumping. It is critical that the materials selected are compatible. If you do not find the wet-end code to meet your application in the configuration guides, you can use the Wet-End Code Selection Guide to determine the correct Head Material, Seats & O-Rings and Balls. If you do not know what materials are compatible with the chemicals you are pumping, refer to the chemical compatibility chart below. We have identified the proper wet-end code for the chemicals in the list. If your chemical is not found in the list, please contact your chemical supplier or visit [www.pulsatron.com](http://www.pulsatron.com) for a complete listing.

PULSAtron Wet-End Code Selection Guide	
<b>Head &amp; Fittings</b>	
A	= 316 Stainless Steel (All models except H8)
K	= PVDF (Kynar) (Consult factory for J7, H8 models)
P	= GFPPL (Polypropylene)
V	= PVC (Poly Vinyl Chloride) (for models rated < 150 psi excluding J7, K7, H7, H8)
W	= PVC (for models > 150 psi and J7, K7, H7, H8)
<b>Seats</b>	
H	= CSPE
T	= TFE (not available with TFE ball over 150 psi)
V	= Viton (150 psi max.)
<b>Balls</b>	
C	= Ceramic
H	= Alloy C (Hastelloy)
S	= 316 Stainless Steel
T	= TFE (not available with TFE seat over 150 psi)

Chemical Compatibility Chart	
Chemical	Liquid End Code
ACETIC ACID, 5 - 10%	PHC
ALUMINUM SULFATE	VHC
AMMONIA, 10%	PHC
BROMINE	KTC
CALCIUM HYPOCHLORITE	VVC
CITRIC ACID, 10 - 20%	PHC
DEAE - Steamline Treatment	ATS
ETHYLENE GLYCOL	PTC
FERRIC CHLORIDE	VTC
FERRIC SULFATE	PTC
FLUOSILICIC ACID	PTT
HYDROCHLORIC ACID, 0 - 37%	PTC
HYDROCHLORIC ACID, 37 - 100%	KTT
HYDROFLUOSILICIC ACID, 20%	PTT
HYDROGEN PEROXIDE, 0 - 30%	VVC
LACTIC ACID	PTC
NITRIC ACID, 0 - 20%	PVC
PHOSPHORIC ACID, 0 - 100%	KTC
POTASSIUM CHLORIDE	PTC
POTASSIUM PERMANGANATE	PTC
SODIUM BI-CARBONATE	PTC
SODIUM BI-SULFATE	PTC
SODIUM BI-SULFITE	PTC
SODIUM CARBONATE	PTC
SODIUM HYDROXIDE, 0 - 50%	PHC
SODIUM HYPOCHLORITE	VVC
SODIUM NITRATE	PTC
SODIUM SILICATE	PHC
SODIUM SULFATE	PHC
SODIUM SULFIDE	PHC
SULFURIC ACID, 0 - 10%	PTC
SULFURIC ACID, 10 - 75%	PTC
SULFURIC ACID, 95 - 100%	KTC

CSPE is generic formulation of Hypalon, a registered trademark of E.I. DuPont Co.  
Viton is a registered trademark of E.I. DuPont Company.

This is an abbreviated version using most common chemicals. Refer to the Chemical Resistance Guide (EMP-030) for a more detailed listing.

## Selecting the Connection Code:

Selecting the proper connection code is probably the most difficult part of choosing a PULSAtron pump. Because of the flexibility built into this product line to meet a large variety of applications, the connection codes are determined by a lot more factors than just the size of the tubing. Connection code is probably the wrong name for this selection because you are selecting more than just the tubing size. This code also determines the type of valves used in the pump. The valve type is determined by factors such as flow rate of the pump, ball type selected and viscosity of the fluid you will be pumping.

### Flow Rate:

The pump you select is rated to pump a certain number of gallons per hour (GPH). When selecting the connection code, please note the GPH limitations and select a connection that fits within the parameters of the pump model that you selected.

### Ball Type:

If the material selected for the balls used in the check valves is TFE, you will probably need to use a spring-loaded connection. This is due to the fact that the weight of the balls will not allow them to seat properly without the spring. See the connection chart for a list of spring loaded connection types.

### Viscosity:

Viscosity of the fluid you are pumping impacts the connection. The higher viscosity fluids (>3000 cps) require larger connection types and spring-loaded valves. Medium viscosity fluids (1000 to 3000 cps) can be pumped without the spring-loaded valves but you must **use SS balls with these connections in order for the balls to seat properly in the valve.**

### Degassing Head:

The degassing head assembly is the solution to pumping gas producing chemicals such as hydrogen peroxide or high strength sodium hypochlorite. The unique de-gas valve system is designed to allow air to be vented from the pump head while minimizing the return fluid volume. It also prevents the pump from losing its prime due to gas build up. The degassing head will be available on all PULSAtron pumps with volumes <44GPD & pressures <150PSI. This feature is only available with the wet-end codes VVC9, VHC9, and VTC9.

## Connection Codes

Code	Connect Type	Suction	Discharge	Spring	GPH Flow Limitations-125 SPM	GPH Flow Limitations-250 SPM	Viscosity	Other Factors
2	Piping	.25" FNPT	.25" FNPT		0 - 1.88	0-3.76	1000 up to 3000 cps w/ SS balls	No Bleed Valve
4	Piping	.25" FNPT	.25" FNPT		1.63 - 10	3.26-20	1000 up to 3000 cps w/ SS balls	No Bleed Valve
6	Piping	.25" FNPT	.25" FNPT	Yes	Up to 10	NA	less than 10,000 cps	No Bleed Valve
8	Piping	.50" FNPT	.50" FNPT	Yes	Up to 25	NA	less than 10,000 cps	No Bleed Valve
C	Piping	.50" FNPT	.50" FNPT		25	50	1000 up to 3000 cps w/ SS balls	No Bleed Valve
G	Piping	.25" FNPT	.25" FNPT	Yes	0 - 1.88	0-3.76	1000 up to 3000 cps w/ SS balls	No Bleed Valve
I	Piping	.50" MNPT	.50" MNPT	Yes	Up to 10	NA	less than 10,000 cps	No Bleed Valve
L	Piping	.50" MNPT	.50" MNPT		0 - 1.88	0-3.76	1000 up to 3000 cps w/ SS balls	No Bleed Valve
X	Piping	.50" MNPT	.50" MNPT		1.63 - 10	3.26-20	1000 up to 3000 cps w/ SS balls	No Bleed Valve
1	Tubing	.25" x .38"	.25" x .38"		0 - 1.88	0-3.76	1000 up to 3000 cps w/ SS balls	
3	Tubing	.38" x .50"	.38" x .50"		1.63 - 10	3.26-20	1000 up to 3000 cps w/ SS balls	
5	Tubing	.50" x .75"	.38" x .50"	Yes	Up to 10	NA	less than 10,000 cps	
7	Tubing	.50" x .75"	.50" FNPT	Yes	Up to 25	NA	less than 10,000 cps	No Bleed Valve
9	Tubing	.25" x .38"	.25" x .38"	Yes	0 - 1.88	0-3.76	1000 up to 3000 cps w/ SS balls	Degas Head/No Bleed Valve
A	Tubing	.38" x .50"	.38" x .50"		0 - 1.88	0-3.76	1000 up to 3000 cps w/ SS balls	
B	Tubing	.50" x .75"	.50" x .75"		25	50	1000 up to 3000 cps w/ SS balls	No Bleed Valve
D	Tubing	.25" x .38"	.25" x .38"	Yes	0 - 1.88	0-3.76	1000 up to 3000 cps w/ SS balls	
E	Tubing	.38" x .50"	.38" x .50"	Yes	0 - 1.88	0-3.76	1000 up to 3000 cps w/ SS balls	
F	Tubing	.38" x .50"	.38" x .50"	Yes	1.63 - 10	3.26-20	1000 up to 3000 cps w/ SS balls	Not Available In PVDF
H	Tubing	.25" x .38"	.25" x .38"		1.63 - 10	3.26-20	1000 up to 3000 cps w/ SS balls	
J	Tubing	.25" x .38"	.25" x .38"		0 - 1.04	0-2.08	1000 up to 3000 cps w/ SS balls	
K	Tubing	.50" x .75"	.50" x .75"	Yes	1.88 - 25 (<50 psi)	NA	less than 10,000 cps	No Bleed Valve
<b>Metric Connections</b>					<b>LPH Flow Limitations</b>	<b>LPH Flow Limitations</b>		
M	Piping	G 1/2 A	G 1/2 A		6.15 - 37.85	12.3-75.7	1000 up to 3000 cps w/ SS balls	
R	Piping	G 1/2 A	G 1/2 A		0 - 7.10	0-14.2	1000 up to 3000 cps w/ SS balls	
P	Tubing	4 x 6 mm	4 x 6 mm		0 - 3.94	0-7.88	1000 up to 3000 cps w/ SS balls	
S	Tubing	6 x 8 mm	6 x 8 mm		> 18.93	> 37.86	1000 up to 3000 cps w/ SS balls	
T	Tubing	6 x 8 mm	6 x 8 mm		0 - 7.10	0-14.2	1000 up to 3000 cps w/ SS balls	Degas Head/No Bleed Valve
U	Tubing	6 x 8 mm	6 x 8 mm		0 - 7.10	0-14.2	1000 up to 3000 cps w/ SS balls	
V	Tubing	12 x 19 mm	12 x 19 mm		> 29.96	>59.92	1000 up to 3000 cps w/ SS balls	No Bleed Valve
W	Tubing	8 x 12 mm	8 x 12 mm		3.94 - 37.85	7.88-75.7	1000 up to 3000 cps w/ SS balls	
Y	Tubing	9 x 12 mm	9 x 12 mm		0 - 7.10	0-14.2	1000 up to 3000 cps w/ SS balls	

- Pumps ranging from 0.25 gph (0.9 lph) to 0.90 gph (3.4 lph) with the stainless steel ball option ("S" in the 9th digit of the model number) must select a connection code with a spring.
- Pumps less than or equal to .25 gph (0.9 lph) require a connection code with a spring and must use a ceramic ball in place of stainless steel.
- Stainless steel head assemblies are only available in piping connections.

# PULSAtron® Selection Guide cont'd

## Suffix Codes:

# LB02SA-PTC1-XXX

← Suffix Code

The last three digits of the model string are referred to as the Suffix Code. It is through the suffix code that the pump can be customized with optional features or customer specific features, e.g. private labeling. If your company has specific features that will be ordered on every pump, contact customer service with a description of what you want customized. We will then assign a unique suffix code that can be used as the last three digits in the model string when you place an order.

### Standard Suffix Code Descriptions:

On the following pages are additional features that can be added to your PULSAtron pump through the use of the Suffix Code. Anytime you order a pump with one of these codes, it will be configured with that option.

#### CZ\_ \_ \_ \_XXX = CE Approval

This suffix code tells us that you require CE Approval on the pump you are ordering. This suffix code is seven to nine digits and can be used in conjunction with other suffix codes by replacing the XXX after the CZ \_ \_ \_ \_ with another suffix code. For instance, if you require CE Approval and a Five Function Valve, the suffix code would be CZUK500.

#### 130 = PVDF Tubing

This suffix code will replace the standard pump tubing with PVDF Tubing.

#### 500 = Five Function Valve

The five function valve is easily installed, no tools required. The valve operates with all PULSAtron models up to 240 GPD. The five function valve is packed with features that increase safety, enhance performance and generally improves the convenience of operation.

### FEATURES

- Pressure Relief – Allows for relief of excessive pressure in discharge line to protect connections and tubing.
- Back Pressure – Maintains output reproducibility and allows metering into atmospheric discharge.
- Anti-Siphon – Prevents siphoning through the pump when point of injection is lower than the pump or into the suction line of another pump. Rated at total vacuum.
- Air Bleed – Used during priming to manually remove air from the pump head.
- Discharge Drain – Depressurize pump discharge line without loosening tubing or fittings. Protects the operator from chemical exposure.

### SPECIFICATIONS

#### Material Of Construction:

Valve Body	Polyvinylidene Flouride (PVDF)
Diaphragm	TFE faced CSPE
O-Rings	TFE
Hardware	18-8 Stainless Steel (Recessed)

#### Maximum Operating

**Pressure:** 250 PSI/17 BAR

**Maximum Flow:** 10 GPH (37.85 LPH)

**Maximum Viscosity:** 1000 CPS

#### Pressure Relief

<b>Settings:</b>	275 PSI (17 BAR) - red
(nominal cracking pressure)	175 PSI (12 BAR) - green
	125 PSI (8.6 BAR) - blue
	50 PSI (2.8 BAR) - black (PVC only)

Note: Pressure relief will occur at no more than 50% above maximum rating of pump.

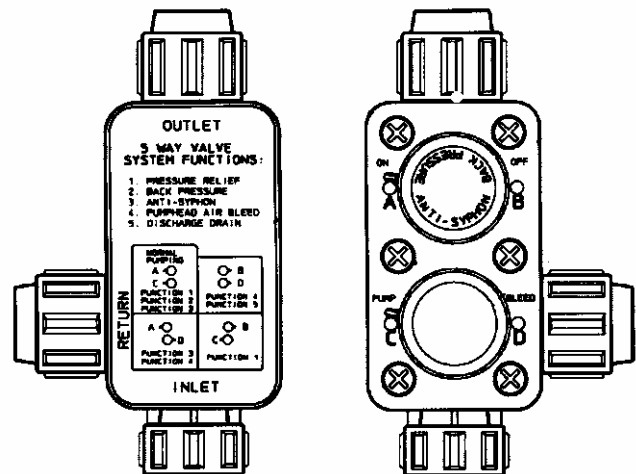

### OPERATION

The functions are selected by setting two dual position selector knobs. The label on the back panel of the valve identifies each function with selector knob positions. The five function valve is compatible with most PULSAtron pumps. Connected to the existing discharge valve the five function valve is capable of handling a large output flow as well as viscous liquids. A return port located on the side body provides flow of chemical back to the solution tank when in the air bleed or drain discharge mode.



## 520 = DG/5FV Five Function Valve with De-Gas

With the DG/5FV you don't have to give up the accuracy and control of a solenoid metering pump in order to pump gaseous solutions.

Available in a variety of materials and popular sizes, the DG/5FV is ready to tackle most applications. Not only does the DG/5FV provide degassing, it is packed with features that increase safety, enhance performance and generally improves the convenience of operation.

### FEATURES

- De-Gas – Bypass gasses and fluid during normal pump operation. Allows for the constant removal of gases that would otherwise “air bind” the pump.
- Back Pressure – Maintains output reproducibility and allows metering into atmospheric discharge.
- Anti-Siphon – Prevents siphoning through the pump when point of injection is lower than the pump or into the suction line of another pump. Rated at total vacuum.
- Air Bleed – Used during priming to manually remove air from the pump head.
- Discharge Drain – Depressurize pump discharge line without loosening tubing or fittings. Protects the operator from chemical exposure.

### SPECIFICATIONS

#### Material Of Construction:

<b>Valve Body</b>	Polyvinylidene Flouride (PVDF)
<b>Diaphragm</b>	TFE faced CSPE
<b>O-Rings</b>	TFE
<b>Hardware</b>	18-8 Stainless Steel (Recessed)
<b>Maximum Flow:</b>	10 GPH (37.85 LPH)
<b>Maximum Viscosity:</b>	1000 CPS
<b>Max Pressure Ratings:</b>	Up to 250 PSI (17 BAR)

Note: Degas/bypass volume is adjustable, typically 1-10% of pump output.

<b>Connections:</b>	1/4" (0.635 cm) Male NPT
	1/2" (1.27 cm) OD tubing
	3/8" (0.95 cm) OD tubing

All ports (input, output & bypass) on the selected valve will be the same

### ITS = Integrated Tank System

The ITS System is a completely integrated tank system constructed of high density UV resistant polyethylene (PE) with a 15 gallon capacity. This tank system is translucent with 5 gallon increments and the tank's low level indicator allows visual monitoring of chemicals without opening the tank. The tight fitting child-proof lid keeps the chemical free of contaminants and protects the surrounding area from chemical fumes.

The ITS System also allows for easy access to the liquid end and control panel of the mounted pump.

A system consists of a chemical tank with lid and bulkhead fittings; a liquid level indicator float assembly; and feeder mounting hardware.

**ITS Tank not available on LM, LP, If you require a different type or size tank, please refer to our accessory price book.**

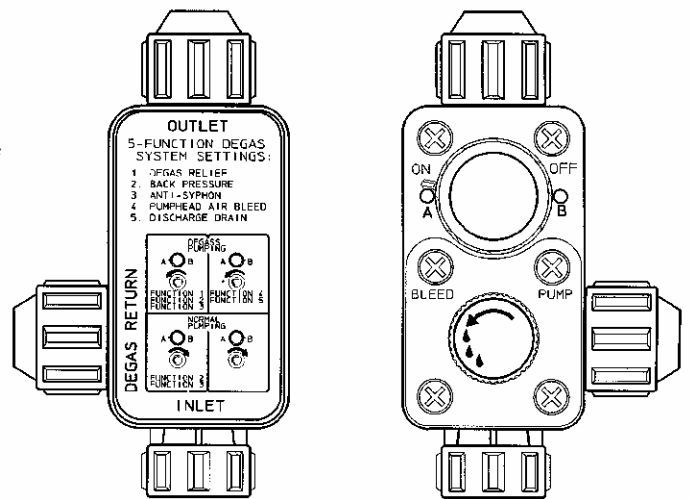

### OPERATION

The functions are selected by setting two dual position selector knobs. The label on the back panel of the DG/5FV identifies each function with selector knob positions.

The DG/5FV is compatible with most PULSAtron pumps. Connected to the existing discharge valve the GG/5FV is capable of handling a large output flow as well as viscous liquids. A return port located on the side body provides flow of chemical back to the solution tank when in the degas, air bleed or drain discharge mode.



# PULSAtron® Electronic Metering Pumps

## Series MP

### Key Features

- Automatic Control, Fully scalable 4-20mA current signal that can also be calibrated to precisely match the current signal reading of the sending device.
- Manual Control allows for a combined 1000:1 turndown resulting in accurate metering for critical applications.
- Flow Verification option is available on select sizes.
- Relay Output for computer interface or AC power allows for external control.
- Six-button Touch Pad Control with internationally recognized symbols for simplified programming.
- Simple Prompts in plain language allow for easy-to-understand instructions for programming. Available in three languages.
- Alarm Signals for signal loss, full count, circuit failure, pulse overflow and pulse rate high. Liquid low level indicator capability is standard.
- Timed Sequences can be set for selected intervals and rate for repetitive metering.
- Pulse Signals can be multiplied or divided by 1 to 999 allowing for pumps to handle peak requirements.
- LCD, 3 line backlit multi-lingual display allows for easy reading and user-friendly programming.
- Calibrated Flow Rate display with total volume pumped last day, month and since last reset.



Tested and Certified by WQA  
against NSF/ANSI 61 & 372.



PVDF and Degassing Head Pumps.  
See [www.wqa.org](http://www.wqa.org) for  
certification parameters.



### Engineering Data

Reproducibility:	+/- 2% at maximum capacity
Viscosity Max CPS :	For viscosity up to 3000 CPS, select connection size 3, 4, B or C with 316SS ball material. Flow rate will determine connection/ball size. Greater than 3000 CPS require spring loaded ball checks. See Selection Guide for proper connection.
Controls:	6-Station Membrane Switch
Status Display:	16-Position LCD Dot Matrix Backlight
LED Indicator Lights, Panel Mount:	Power On - Green Pulsing - Green Flashing Stop - Red
Stroke Frequency Max SPM:	125
External Stroke Frequency Control (Automatic):	4-20 mADC, 20-4 mADC External Pacing
Output Relay (Signal Level Option):	24 VDC, 10 mA
Output Relay (Power Option):	250 VAC, 50/60 HZ, 0.5A
Stroke Frequency Turn-Down Ratio:	100:1
Stroke Length Turn-Down Ratio:	10:1

### Engineering Data

Power Input:	115 VAC/50-60 HZ/1 ph 230 VAC/50-60 HZ/1 ph
Average Current Draw:	
@ 115 VAC; Amps:	1.0 Amps
@ 230 VAC; Amps:	0.5 Amps
Peak Input Power:	300 Watts
Average Input Power @ Max SPM:	130 Watts

### Pressure and Flow Rate Capacity

MODEL		LMK2	LMB2	LMA2	LMD3	LMB3	LMA3	LMK3	LMF4	LMD4	LMB4	LMH4	LMG4	LME4	LMK5	LMH5	LMH6	LMK7	LMH7	LMH8	
Capacity	GPH	0.13	0.21	0.25	0.50	0.50	0.50	0.60	0.85	0.90	1.00	1.70	1.75	1.85	2.50	3.15	5.00	8.00	10.00	21.00	
	GPD	3	5	6	12	12	12	14	20	22	24	41	42	44	60	76	120	192	240	504	
	(max.) LPH	0.5	0.8	0.9	1.9	1.9	1.9	2.3	3.2	3.4	3.8	6.4	6.6	7.0	9.5	11.9	18.9	30.3	37.9	79.5	
Pressure	PSIG	300	250	150	250	150	100	100	250	150	100	250	150	100	150	150	100	50	35	20	
	(max.) BAR	21	17	10	17	10	7	7	17	10	7	17	10	7	10	10	7	3.3	2.4	1.3	
Connections	Tubing	1/4" ID X 3/8" OD 3/8" ID X 1/2" OD												3/8" ID X 1/2" OD 1/2" ID X 3/4" OD (LPH8 ONLY) FLOW VERIFICATION (See Note)							
	Piping	1/4" FNPT												1/4" FNPT 1/2" FNPT							

Note: Flow Verification: Available on K3, B4 and E4 with connection code 1; H6, K7 and H7 with connection code H; 1/4" ID x 3/8" OD only.

**PULSAtron Series MP Selection Guide**

LM \_\_\_

<b>MODELS:</b>	<b>K2</b>	= 0.13 gph / 3 gpd ( 0.5 lph) max pres.: 300 PSI (21 BAR)
	<b>B2</b>	= 0.21 gph / 5 gpd ( 0.8 lph) max pres.: 250 PSI (17 BAR)
	<b>D3</b>	= 0.50 gph / 12 gpd ( 1.9 lph) max pres.: 250 PSI (17 BAR)
	<b>F4</b>	= 0.85 gph / 20 gpd ( 3.2 lph) max pres.: 250 PSI (17 BAR)
	<b>H4</b>	= 1.70 gph / 41 gpd ( 6.4 lph) max pres.: 250 PSI (17 BAR)
	<b>A2</b>	= 0.25 gph / 6 gpd ( 0.9 lph) max pres.: 150 PSI (10 BAR)
	<b>B3</b>	= 0.50 gph / 12 gpd ( 1.9 lph) max pres.: 150 PSI (10 BAR)
	<b>D4</b>	= 0.90 gph / 22 gpd ( 3.4 lph) max pres.: 150 PSI (10 BAR)
	<b>G4</b>	= 1.75 gph / 42 gpd ( 6.6 lph) max pres.: 150 PSI (10 BAR)
	<b>K5</b>	= 2.50 gph / 60 gpd ( 9.5 lph) max pres.: 150 PSI (10 BAR)
	<b>H5</b>	= 3.15 gph / 76 gpd (11.9 lph) max pres.: 150 PSI (10 BAR)
	<b>A3</b>	= 0.50 gph / 12 gpd ( 1.9 lph) max pres.: 100 PSI ( 7 BAR)
	<b>K3</b>	= 0.60 gph / 14 gpd ( 2.3 lph) max pres.: 100 PSI ( 7 BAR)
	<b>B4</b>	= 1.00 gph / 24 gpd ( 3.8 lph) max pres.: 100 PSI ( 7 BAR)
	<b>E4</b>	= 1.85 gph / 44 gpd ( 7.0 lph) max pres.: 100 PSI ( 7 BAR)
<b>G5</b>	= 4.00 gph / 96 gpd (15.1 lph) max pres.: 100 PSI (7 BAR)	
<b>H6</b>	= 5.00 gph / 120 gpd (18.9 lph) max pres.: 100 PSI ( 7 BAR)	
<b>K7</b>	= 8.00 gph / 192 gpd (30.3 lph) max pres.: 50 PSI (3.3 BAR)	
<b>H7</b>	= 10.0 gph / 240 gpd (37.9 lph) max pres.: 35 PSI (2.4 BAR)	
<b>H8</b>	= 21.0 gph / 504 gpd (79.5 lph) max pres.: 20 PSI (1.3 BAR)	

<b>CONTROLS:</b>	<b>T</b>	= Signal Level Output Relay
	<b>K</b>	= Power Level Output Relay

<b>ELECTRICAL:</b>	<b>A</b>	= 115 Volt / 50-60Hz
	<b>1</b>	= 115 Volt / 50-60Hz (without agency approvals)
	<b>B</b>	= 230 Volt / 50-60Hz / 1ph with 6' (1.8m) 3-wire US Plug
	<b>2</b>	= 230 Volt / 50-60Hz (without agency approvals)

<b>LIQUID END MATERIALS:</b> <b>Pump Head &amp; Fittings/Seats &amp; O-rings/Balls</b>	<b>PTC</b>	= GFPP / TFE / Ceramic
	<b>KTC</b>	= PVDF / TFE / Ceramic (not available on H8)
	<b>VHC</b>	= PVC / CSPE / Ceramic (not available on H7, H8, K7)
	<b>VTC</b>	= PVC / TFE / Ceramic (models <= 150 psi excluding H7, H8, K7)
	<b>WTC</b>	= PVC / TFE / Ceramic (models > 150 psi and H7, H8, K7)
	<b>VVC</b>	= PVC / Viton / Ceramic (not available on H8)
	<b>ATS</b>	= 316 S.S. / TFE / 316 S.S. (must use FNPT piping connection) (not available on H8)

See page 6 for additional liquid end materials.

<b>CONNECTION SIZES:</b>	<b>1</b>	= Tubing .25" I.D. x .38" O.D. / .25" Ball, 0 - 1.88 GPH
	<b>3</b>	= Tubing .38" I.D. x .50" O.D. / .38" Ball, 1.63 - 10 GPH
	<b>9</b>	= Degas Head: .25" I.D. x .38" O.D. / 0-1.83 GPH
	<b>J</b>	= Tubing, .25" I.D. x .38" O.D. / .19 Ball; 0 - 1.04 GPH
	<b>METRIC:</b>	
	<b>M</b>	= G 1/2 A Threads, .38" Ball, 6.15 - 37.85 LPH
	<b>R</b>	= G 1/2 A Threads, .25" Ball, 0 - 7.10 LPH
	<b>Y</b>	= 9 x 12mm, .25" Ball, 0 - 7.10 LPH

Please Refer to page 7 for additional connection sizes. All pumps with tubing connections come with the following items (except for LMH8, LPH8, HV Series pumps): 4' Suction, 4' Return, 8' discharge tubing, footvalve/strainer assy., injection valve and bleed valve.

<b>SUFFIX CODES:</b>	<b>XXX</b>	= No Additional Options
	<b>130</b>	= PVDF Tubing
	<b>500</b>	= Five Function Valve
	<b>520</b>	= Five Function Degas Valve
	<b>FVE</b>	= Flow Verification / EPDM (not available on pumps greater than 100 psi or H8 pump)
	<b>FVV</b>	= Flow Verification / Viton (not available on pumps greater than 100 psi or H8 pump)
	<b>ITS</b>	= 15 gal. ITS Tank System (ITS Tank not available on LM, LP, LT, and LE: H4, H5, H6, H7, H8, J7, K7 models)
	<b>CZ_XXX</b>	= CE Approval (CZXXX=Europe; CZUKXXX=UK; CZSUIXXX=Switzerland/Liechtenstein)

See pages 8 & 9 for additional information and specs.

A completed model number should look like 'LMB3TA-PTC1-XXX'

**Dimensions**

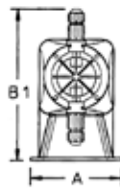
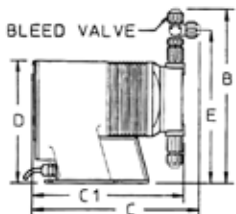

Series MP Dimensions (inches)

Model No.	A	B	B1	C	C1	D	E	Shpg Wt	Model No.	A	B	B1	C	C1	D	E	Shpg Wt
LMA2	5.4	10.3	-	10.8	-	7.5	8.9	13	LMH4	6.2	10.9	-	11.2	-	8.2	9.5	21
LMA3	5.4	10.6	-	10.7	-	7.5	9.2	13	LMH5	6.2	11.3	-	11.2	-	8.2	9.9	21
LMB2	5.4	10.3	-	10.8	-	7.5	8.9	13	LMH6	6.2	11.3	-	11.2	-	8.2	9.9	21
LMB3	5.4	10.6	-	10.7	-	7.5	9.2	13	LMH7	6.1	11.7	-	11.2	-	8.2	10.3	21
LMB4	5.4	10.6	-	10.7	-	7.5	9.2	13	LMH8*	6.1	-	10.9	-	10.6	8.2	-	25
LMD3	5.4	10.6	-	11.2	-	7.5	9.2	15	LMK2	5.4	10.3	-	10.8	-	7.5	8.9	13
LMD4	5.4	10.6	-	11.2	-	7.5	9.2	15	LMK3	5.4	10.6	-	10.7	-	7.5	9.2	13
LME4	5.4	10.6	-	11.2	-	7.5	9.2	15	LMK5	5.4	10.9	-	11.7	-	7.5	9.5	18
LMF4	5.4	10.6	-	11.7	-	7.5	9.2	18	LMK7	6.1	11.7	-	11.2	-	8.2	10.3	21
LMG4	5.4	10.6	-	11.7	-	7.5	9.2	18									

NOTE: Inches X 2.54 = cm / \* the LMH8 is designed without a bleed valve available

# PULSAtron® Electronic Metering Pumps

## Series E PLUS

### Key Features

- Automatic Control, available with 4-20 mA DC direct or external pacing, with stop function.
- Manual Control by on-line adjustable stroke rate and stroke length.
- Auto-Off-Manual switch.
- Highly Reliable timing circuit.
- Circuit Protection against voltage and current upsets.
- Panel Mounted Fuse.
- Solenoid Protection by thermal overload with auto reset.
- Water Resistant, for outdoor and indoor applications.
- Indicator Lights, panel mounted.
- Guided Ball Check Valve Systems, to reduce back flow and enhance outstanding priming characteristics.
- Safe & Easy Priming with durable leak-free bleed valve assembly (standard).



Tested and Certified by WQA  
against NSF/ANSI 61 & 372.



PVDF and Degassing Head Pumps.  
See [www.wqa.org](http://www.wqa.org) for  
certification parameters.

Intertek  
9700150

Intertek  
9700150

### Engineering Data

Reproducibility:	+/- 2% at maximum capacity
Viscosity Max CPS :	For viscosity up to 3000 CPS, select connection size 3, 4, B or C with 316SS ball material. Flow rate will determine connection/ball size. Greater than 3000 CPS require spring loaded ball checks. See Selection Guide for proper connection.
Stroke Frequency Max SPM:	125
Stroke Frequency Turn-Down Ratio:	10:1
Stroke Length Turn-Down Ratio:	10:1
Power Input:	115 VAC/50-60 HZ/1 ph 230 VAC/50-60 HZ/1 ph
Average Current Draw:	
@ 115 VAC; Amps:	1.0 Amps
@ 230 VAC; Amps:	0.5 Amps
Peak Input Power:	300 Watts
Average Input Power @ Max SPM:	130 Watts

### Pressure and Flow Rate Capacity

MODEL	LPK2	LPB2	LPA2	LPD3	LPB3	LPA3	LPK3	LPF4	LPD4	LPB4	LPH4	LPG4	LPE4	LPK5	LPH5	LPG5	LPH6	LPK7	LPH7	LPJ7	LPH8	
Capacity nominal	GPH	0.13	0.21	0.25	0.5	0.50	0.50	0.60	0.85	0.90	1.00	1.70	1.75	1.85	2.50	3.15	4	5.00	8.00	10.00	10.00	25.00
	GPD	3	5	6	12	12	12	14	20	22	24	41	42	44	60	76	96	120	192	240	240	600
Capacity (max.)	LPH	0.5	0.8	0.9	1.9	1.9	1.9	2.3	3.2	3.4	3.8	6.4	6.6	7	9.5	11.9	15.1	18.9	30.3	37.9	37.9	94.6
	PSIG	300	250	150	250	150	100	100	250	150	100	250	150	100	150	150	100	100	50	35	80	30
Pressure (max.)	BAR	21	17	10	17	10	7	7	17	10	7	17	10	7	10	10	7	3.3	2.4	5.5	2	
	Connections	1/4" ID X 3/8" OD 3/8" ID X 1/2" OD											3/8" ID X 1/2" OD 1/2" ID X 3/4" OD (LPH8 ONLY)									
	Tubing	1/4" FNPT											1/4" FNPT 1/2" FNPT									
	Piping																					

### PULSAtron Series E Plus Selection Guide

<b>MODELS:</b>		K2 = 0.13 gph / 3 gpd ( 0.5 lph) max pres.: 300 PSI (21 BAR)	LP	---	---	---	---	---
		B2 = 0.21 gph / 5 gpd ( 0.8 lph) max pres.: 250 PSI (17 BAR)						
		D3 = 0.50 gph / 12 gpd ( 1.9 lph) max pres.: 250 PSI (17 BAR)						
		F4 = 0.85 gph / 20 gpd ( 3.2 lph) max pres.: 250 PSI (17 BAR)						
		H4 = 1.70 gph / 41 gpd ( 6.4 lph) max pres.: 250 PSI (17 BAR)						
		A2 = 0.25 gph / 6 gpd ( 0.9 lph) max pres.: 150 PSI (10 BAR)						
		B3 = 0.50 gph / 12 gpd ( 1.9 lph) max pres.: 150 PSI (10 BAR)						
		D4 = 0.90 gph / 22 gpd ( 3.4 lph) max pres.: 150 PSI (10 BAR)						
		G4 = 1.75 gph / 42 gpd ( 6.6 lph) max pres.: 150 PSI (10 BAR)						
		K5 = 2.50 gph / 60 gpd ( 9.5 lph) max pres.: 150 PSI (10 BAR)						
		H5 = 3.15 gph / 76 gpd ( 11.9 lph) max pres.: 150 PSI (10 BAR)						
		A3 = 0.50 gph / 12 gpd ( 1.9 lph) max pres.: 100 PSI (7 BAR)						
		K3 = 0.60 gph / 14 gpd ( 2.3 lph) max pres.: 100 PSI (7 BAR)						
		B4 = 1.00 gph / 24 gpd ( 3.8 lph) max pres.: 100 PSI (7 BAR)						
		E4 = 1.85 gph / 44 gpd ( 7.0 lph) max pres.: 100 PSI (7 BAR)						
		G5 = 4.00 gph / 96 gpd ( 15.1 lph) max pres.: 100 PSI (7 BAR)						
		H6 = 5.00 gph / 120 gpd ( 18.9 lph) max pres.: 100 PSI (7 BAR)						
		K7 = 8.00 gph / 192 gpd ( 30.3 lph) max pres.: 50 PSI (3.3 BAR)						
		H7 = 10.0 gph / 240 gpd ( 37.9 lph) max pres.: 35 PSI (2.4 BAR)						
		J7 = 10.0 gph / 240 gpd ( 37.9 lph) max pres.: 80 PSI (5.5 BAR)						
		H8 = 25.0 gph / 600 gpd ( 94.6 lph) max pres.: 30 PSI (2 BAR)						
<b>CONTROLS:</b>		S = Manual On/Off						
		M = 4-20mADC Direct, w/ Stop						
		E = External/Remote Pacing, w/ Stop						
<b>ELECTRICAL:</b>		A = 115 Volt / 50-60Hz						
		1 = 115 Volt / 50-60Hz (without agency approvals)						
		B = 230 Volt / 50-60Hz / 1ph with 6' (1.8m) 3-wire US Plug						
		2 = 230 Volt / 50-60Hz (without agency approvals)						
<b>LIQUID END MATERIALS:</b>		PTC = GFPP / TFE / Ceramic						
		PTT = GFPP / TFE / TFE						
Pump Head & Fittings/Seats & O-rings/Balls		KTC = PVDF / TFE / Ceramic (not available on H8)						
		VHC = PVC / CSPE / Ceramic (not available on H7, H8, J7, K7)						
		VTC = PVC / TFE / Ceramic (models <= 150 psi excluding H7, H8, J7, K7)						
		WTC = PVC / TFE / Ceramic (models > 150 psi and H7, H8, J7, K7)						
		ATS = 316 S.S. / TFE / 316 S.S. (must use FNPT piping connection) (not available on H8)						
See page 6 for additional liquid end materials.								
<b>CONNECTION SIZES:</b>		1 = Tubing .25" I.D. x .38" O.D. / .25" Ball, 0 - 1.88 GPH						
		3 = Tubing .38" I.D. x .50" O.D. / .38" Ball, 1.63 - 10 GPH						
		4 = Piping .25" FNPT / .38" Ball, 1.63 - 10 GPH						
		B = Tubing .50" I.D. x .75" O.D. / .50" Ball, 25 GPH only						
		<b>METRIC:</b>						
		M = G 1/2 A Threads, .38" Ball, 6.15 - 37.85 LPH						
		R = G 1/2 A Threads, .25" Ball, 0 - 7.10 LPH						
		Y = 9 x 12mm, .25" Ball, 0 - 7.10 LPH						
Please Refer to page 7 for additional connection sizes. All pumps with tubing connections come with the following items (except for LMH8, LPH8, HV Series pumps): 4' Suction, 4' Return, 8' discharge tubing, footvalve/strainer assy., injection valve and bleed valve.								
<b>SUFFIX CODES:</b>		XXX = No Additional Options						
		130 = PVDF Tubing						
		500 = Five Function Valve						
		520 = Five Function Degas Valve						
		ITS = 15 gal. ITS Tank System (ITS Tank not available on LM, LP, LT, and LE: H4, H5, H6, H7, H8, J7, K7 models)						
		CZ XXX = CE Approval (CZXXX=Europe; CZUKXXX=UK; CZSUIXXX=Switzerland/Liechtenstein)						
See pages 8 & 9 for additional information and specs.								
A completed model number should look like 'LPB3SA-PTC1-XXX'								

### Dimensions

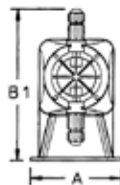
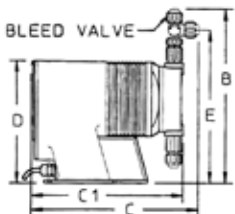

Series E Plus Dimensions (inches)																	
Model No.	A	B	B1	C	C1	D	E	Shpg Wt	Model No.	A	B	B1	C	C1	D	E	Shpg Wt
LPA2	5.4	10.3	-	10.8	-	7.5	8.9	13	LPH4	6.2	10.9	-	11.2	-	8.2	9.5	21
LPA3	5.4	10.6	-	10.7	-	7.5	9.2	13	LPH5	6.2	11.3	-	11.2	-	8.2	9.9	21
LPB2	5.4	10.3	-	10.8	-	7.5	8.9	13	LPG5	6.2	11.3	-	11.2	-	8.2	9.9	21
LPB3	5.4	10.6	-	10.7	-	7.5	9.2	13	LPH6	6.2	11.3	-	11.9	-	8.2	9.9	21
LPB4	5.4	10.6	-	10.7	-	7.5	9.2	13	LPH7	6.1	11.7	-	11.9	-	8.2	10.3	21
LPD3	5.4	10.6	-	11.2	-	7.5	9.2	15	LPH8*	6.1	-	10.9	-	11.3	8.2	-	26
LPD4	5.4	10.6	-	11.2	-	7.5	9.2	15	LPK2	5.4	10.3	-	10.8	-	7.5	8.9	13
LPE4	5.4	10.6	-	11.2	-	7.5	9.2	15	LPK3	5.4	10.6	-	10.7	-	7.5	9.2	13
LPF4	5.4	10.6	-	11.7	-	7.5	9.2	18	LPK5	5.4	10.9	-	11.7	-	7.5	9.5	18
LPG4	5.4	10.6	-	11.7	-	7.5	9.2	18	LPK7	6.1	11.7	-	11.2	-	8.2	10.3	21
									LPJ7	6.1	10.0	-	10.7	-	-	-	21

NOTE: Inches X 2.54 = cm /\* the LPH8 is designed without a bleed valve available

# PULSAtron® Electronic Metering Pumps

## Series HV

### Key Features

- Automatic Control, available with 4-20 mA DC direct or external pacing, with stop function.
- Manual Control by on-line adjustable stroke rate and stroke length.
- Agency approved for demanding OUTDOOR and indoor applications.
- Auto-Off-Manual switch.
- Highly Reliable timing circuit.
- Circuit Protection against voltage and current upsets.
- Panel Mounted Fuse.
- Solenoid Protection by thermal overload with auto reset.
- Water Resistant, for outdoor and indoor applications.
- Indicator Lights, panel mounted.
- Guided Ball Check Valve Systems, to reduce back flow and enhance outstanding priming characteristics.
- Viscosities to 20,000 CPS.



Tested and Certified by WQA  
against NSF/ANSI 61 & 372.



PVDF and Degassing Head Pumps.  
See [www.wqa.org](http://www.wqa.org) for  
certification parameters.



Intertek  
9700150



Intertek  
9700150



### Engineering Data

Reproducibility:	+/- 2% at maximum capacity
Viscosity Max CPS :	20,000 CPS
Stroke Frequency Max SPM:	125
Stroke Frequency Turn-Down Ratio:	10:1
Stroke Length Turn-Down Ratio:	10:1
Power Input:	115 VAC/50-60 HZ/1 ph 230 VAC/50-60 HZ/1 ph
Average Current Draw:	
@ 115 VAC; Amps:	1.0 Amps
@ 230 VAC; Amps:	0.5 Amps
Peak Input Power:	300 Watts
Average Input Power @ Max SPM:	130 Watts

### Pressure and Flow Rate Capacity

MODEL		LVB3	LVF4	LVG4	LVG5	L VH7
Capacity	GPH	0.50	1.00	2.00	4.00	10.00
	nominal					
	GPD	12	24	48	96	240
Capacity (max.)	LPH	1.9	3.8	7.6	15.1	37.9
	PSIG	150	150	110	110	80
Pressure (max.)	BAR	10	10	7	7	5.6
	Connections	Tubing (S) .50" I.D. X .75" O.D. .38" I.D. X .50" OD (LVB3 & F4 only) (S & D) .50" I.D. X .75" O.D. (LVG4,G5 & H7 only)				

### PULSAtron Series HV Selection Guide

		LV _ _ _ _ _
<b>MODELS:</b>	<b>B3</b>	= 0.50 gph / 12 gpd ( 1.9 lph) max pres.: 150 PSI (10 BAR)
	<b>F4</b>	= 1.00 gph / 24 gpd ( 3.8 lph) max pres.: 150 PSI (10 BAR)
	<b>G4</b>	= 2.00 gph / 48 gpd ( 7.6 lph) max pres.: 110 PSI (7 BAR)
	<b>G5</b>	= 4.00 gph / 96 gpd (15.1 lph) max pres.: 110 PSI (7 BAR)
	<b>H7</b>	= 10.0 gph / 240 gpd (37.9 lph) max pres.: 80 PSI (5.6 BAR)
<b>CONTROLS:</b>	<b>S</b>	= Manual On/Off
	<b>M</b>	= 4-20mADC Direct, w/ Stop
	<b>E</b>	= External/Remote Pacing, w/ Stop
<b>ELECTRICAL:</b>	<b>A</b>	= 115 Volt / 50-60Hz
	<b>1</b>	= 115 Volt / 50-60Hz (without agency approvals)
	<b>B</b>	= 230 Volt / 50-60Hz / 1ph with 6' (1.8m) 3-wire US Plug
	<b>2</b>	= 230 Volt / 50-60Hz (without agency approvals)
<b>LIQUID END MATERIALS:</b>	<b>PTT</b>	= GFPP / TFE / TFE - LVB3 & F4 only
	<b>PTS</b>	= GFPP / TFE / 316 SS - LVG4, G5 & H7 only
<b>Pump Head &amp; Fittings/Seats &amp; O-rings/Balls</b>	<b>WTS</b>	= PVC / TFE / 316 SS - LVH7 only
	<b>VTT</b>	= PVC / TFE / TFE - LVB3 & F4 only
	<b>VTS</b>	= PVC / TFE / 316 SS - LVG5 & G4 No other liquid end materials available.
<b>CONNECTION SIZES:</b>	<b>5</b>	= Tubing (S) .50" I.D. x .75" O.D. / .38" I.D. x .50" O.D. - LVB3 & F4 only
	<b>K</b>	= Tubing .50" I.D. x .75" O.D. - LVG4, G5 & H7 only
<b>No other connection sizes available. Pumps come with 4' suction tubing and 8' discharge tubing. No bleed valve available.</b>		
<b>SUFFIX CODES</b>	<b>XXX</b>	= No Additional Options
<b>See pages 8 &amp; 9 for additional information and specs.</b>		
A completed model number should look like 'LVB3SA-VTT5-XXX'		

### Dimensions

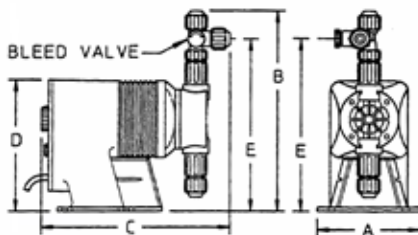

Series HV Dimensions (inches)					
Model No.	A	B	C	D	Shipping Weight
LVB3	5.4	9.3	9.5	7.5	13
LVF4	5.4	10.8	10.8	7.5	18
LVG4	5.4	9.5	10.6	7.5	18
LVG5	5.4	10.8	10.8	7.5	18
LVH7	6.1	11.5	11	8.2	25

NOTE: Inches X 2.54 = cm

# PULSAtron® Electronic Metering Pumps

## Series E Key Features

- Manual Control by on-line adjustable stroke rate and stroke length.
- Agency approved for demanding OUTDOOR and indoor applications.
- Highly Reliable timing circuit.
- Water Resistant excellent for OUTDOOR and indoor applications.
- Internally Dampened To Reduce Noise, very acceptable for household installations.
- Guided Ball Check Valve Systems, to reduce back flow and enhance outstanding priming characteristics.
- Premium Standard Wetted Component Materials.
- Few Moving Parts and Wall Mountable.
- Safe & Easy Priming with durable leak-free bleed valve assembly (standard).



Tested and Certified by WQA  
against NSF/ANSI 61 & 372.



PVDF and Degassing Head Pumps.  
See [www.wqa.org](http://www.wqa.org) for  
certification parameters.

## Engineering Data

Reproducibility:	+/- 3% at maximum capacity
Viscosity Max CPS :	For viscosity up to 3000 CPS, select connection size 3, 4, B or C with 316SS ball material. Flow rate will determine connection/ball size. Greater than 3000 CPS require spring loaded ball checks. See Selection Guide for proper connection.
Stroke Frequency Max SPM:	125
Stroke Frequency Turn-Down Ratio:	10:1
Stroke Length Turn-Down Ratio:	10:1
Power Input:	115 VAC/50-60 HZ/1 ph 230 VAC/50-60 HZ/1 ph
Average Current Draw:	
@ 115 VAC; Amps:	1.0 Amps
@ 230 VAC; Amps:	0.5 Amps
Peak Input Power:	300 Watts
Average Input Power @ Max SPM:	130 Watts

## Pressure and Flow Rate Capacity

MODEL		LE12	LE02	LE33	LE13	LE03	LE34	LE14	LE44
Capacity nominal (max.)	GPH	0.21	0.25	0.50	0.50	0.50	0.90	1.00	1.85
	GPD	5	6	12	12	12	22	24	44
	LPH	0.8	0.9	1.9	1.9	1.9	3.4	3.8	7
Pressure (max.)	PSIG	250	150	250	150	100	150	100	100
	BAR	17	10	17	10	7	10	7	7
Connections	Tubing	1/4" ID X 3/8" OD							
		3/8" ID X 1/2" OD							
	Piping	1/4" FNPT							



### PULSAtron Series E Selection Guide

<b>MODELS:</b>	12	= 0.21 gph / 5 gpd ( 0.8 lph) max pres.: 250 PSI (17 BAR)
	33	= 0.50 gph / 12 gpd ( 1.9 lph) max pres.: 250 PSI (17 BAR)
	02	= 0.25 gph / 6 gpd ( 0.9 lph) max pres.: 150 PSI (10 BAR)
	13	= 0.50 gph / 12 gpd ( 1.9 lph) max pres.: 150 PSI (10 BAR)
	34	= 0.90 gph / 22 gpd ( 3.4 lph) max pres.: 150 PSI (10 BAR)
	03	= 0.50 gph / 12 gpd ( 1.9 lph) max pres.: 100 PSI (7 BAR)
	14	= 1.00 gph / 24 gpd ( 3.8 lph) max pres.: 100 PSI (7 BAR)
	44	= 1.85 gph / 44 gpd ( 7.0 lph) max pres.: 100 PSI (7 BAR)

**CONTROLS:** S = No Options Available

<b>ELECTRICAL:</b>	A	= 115 Volt / 50-60Hz
	1	= 115 Volt / 50-60Hz (without agency approvals)
	B	= 230 Volt / 50-60Hz / 1ph with 6' (1.8m) 3-wire US Plug
	2	= 230 Volt / 50-60Hz (without agency approvals)

<b>LIQUID END MATERIALS:</b> Pump Head & Fittings/Seats & O-rings/Balls	PHC	= GFPP / CSPE / Ceramic
	PTC	= GFPP / TFE / Ceramic
	KTC	= PVDF / TFE / Ceramic (not available on J7 or H8)
	VHC	= PVC / CSPE / Ceramic (not available on H7, H8, J7, K7)
	VTC	= PVC / TFE / Ceramic (models <= 150 psi excluding H7, H8, J7, K7)
	WTC	= PVC / TFE / Ceramic (models > 150 psi and H7, H8, J7, K7)
	ATS	= 316 S.S. / TFE / 316 S.S. (must use FNPT piping connection) (not available on J7 or H8)

See page 6 for additional liquid end materials.

<b>CONNECTION SIZES:</b>	1	= Tubing .25" I.D. x .38" O.D. / .25" Ball, 0 - 1.88 GPH
	3	= Tubing .38" I.D. x .50" O.D. / .38" Ball, 1.63 - 10 GPH
	<b>METRIC:</b>	
	M	= G 1/2 A Threads, .38" Ball, 6.15 - 37.85 LPH
	P	= 4 x 6mm, .25" Ball, 0 - 3.94 LPH

Please Refer to page 7 for additional connection sizes. All pumps with tubing connections come with the following items (except for LMH8, LPH8, HV SAeries pumps): 4' Suction, 4' Return, 8' discharge tubing, footvalve/strainer assy., injection valve and bleed valve.

<b>SUFFIX CODES:</b>	XXX	= No Additional Options
	130	= PVDF Tubing
	500	= Five Function Valve
	520	= Five Function Degas Valve
	ITS	= 15 gal. ITS Tank System (ITS Tank not available on LM, LP, LT, and LE: H4, H5, H6, H7, H8, J7, K7 models)
	CZ_XXX	= CE Approval (CZXXX=Europe; CZUKXXX=UK; CZSUIXXX=Switzerland/Liechtenstein)

See pages 8 & 9 for additional information and specs.

A completed model number should look like 'LE33SA-PTC1-XXX'

## Dimensions

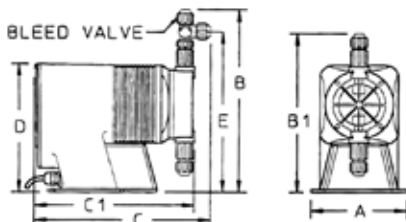

Series E Dimensions (inches)								
Model No.	A	B	B1	C	C1	D	E	Shipping Weight
LE02	5	9.6	-	9.5	-	6.4	8.2	7
LE03	5	9.8	-	9.5	-	6.4	8.4	7
LE12	5	9.6	-	9.5	-	6.4	8.2	7
LE13	5	9.8	-	9.5	-	6.4	8.4	7
LE14	5	9.8	-	9.5	-	6.4	8.4	7
LE33	5.4	10.6	-	11.2	-	7.5	9.2	12
LE34	5.4	10.6	-	11.2	-	7.5	9.2	12
LE44	5.4	10.6	-	11.2	-	7.5	9.2	12

NOTE: Inches X 2.54 = cm

# PULSAtron® Electronic Metering Pumps

## Series E-DC Key Features

- Manual Control by on-line adjustable stroke rate and stroke length.
- Agency approved for demanding OUTDOOR and indoor applications.
- Highly Reliable timing circuit.
- Water Resistant excellent for OUTDOOR and indoor applications.
- Internally Dampened To Reduce Noise, very acceptable for household installations.
- Guided Ball Check Valve Systems, to reduce back flow and enhance outstanding priming characteristics.
- Premium Standard Wetted Component Materials.
- Few Moving Parts and Wall Mountable.
- Safe & Easy Priming with durable leak-free bleed valve assembly (standard).



Tested and Certified by WQA  
against NSF/ANSI 61 & 372.



PVDF and Degassing Head Pumps.  
See [www.wqa.org](http://www.wqa.org) for  
certification parameters.

## Engineering Data

Reproducibility:	+/- 3% at maximum capacity
Viscosity Max CPS :	
LS02, 13:	300 CPS
LS14, 44:	1000 CPS
Stroke Frequency Max SPM:	125
Stroke Frequency Turn-Down Ratio:	10:1
Stroke Length Turn-Down Ratio:	10:1
Power Input:	2.6 VDC Nominal Range 11.8-14.0 VDC
Average Current Draw:	
LS02, 13, 14 Amps:	4.0 Amps
LS44 Amps:	8.0 Amps
Peak Input Power:	
LS02, 13, 14 Power:	138.6 Watts
LS44 Power:	189 Watts
Average Input Power @ Max SPM:	
LS02, 13, 14 Power:	50.4 Watts
LS44 Power:	100.8 Watts

## Pressure and Flow Rate Capacity

MODEL		LS02	LS13	LS14	LS44
Capacity nominal (max.)	GPH	0.25	0.50	1.00	1.85
	GPD	6	12	24	44
	LPH	0.9	1.9	3.8	7.0
Pressure (max.)	PSIG	150	150	100	100
	BAR	10	10	7	7
Connections	Tubing	1/4" ID X 3/8" OD			
		3/8" ID X 1/2" OD			
	Piping	1/4" FNPT			

### PULSAtron Series E-DC Selection Guide

<b>MODELS:</b>	02 = 0.25 gph / 6 gpd (0.9 lph) max pres.: 150 PSI (10 BAR) 13 = 0.50 gph / 12 gpd ( 1.9 lph) max pres.: 150 PSI (10 BAR) 14 = 1.00 gph / 24 gpd ( 3.8 lph) max pres.: 100 PSI (7 BAR) 44 = 1.85 gph / 44 gpd ( 7.0 lph) max pres.: 100 PSI (7 BAR)	LS _ _	S	4	-	-	-
<b>CONTROLS:</b>	S = No Options Available						
<b>ELECTRICAL:</b>	4 = 12V DC						
<b>LIQUID END MATERIALS:</b>	PHC = GFPP / CSPE / Ceramic PTC = GFPP / TFE / Ceramic Pump Head & Fittings/Seats & O-rings/Balls PVC = GFPP / Viton / Ceramic VTC = PVC / TFE / Ceramic						
See page 6 for additional liquid end materials.							
<b>CONNECTION SIZES:</b>	1 = Tubing .25" I.D. x .38" O.D. / .25" Ball, 0 - 1.88 GPH J = Tubing .25" I.D. x .38" O.D. / 19" Ball, 0 - 1.04 GPH <b>METRIC:</b> M = G 1/2 A Threads, .38" Ball, 6.15 - 37.85 LPH R = G 1/2 A Threads, .25" Ball, 0 - 7.10 LPH						
Please Refer to page 7 for additional connection sizes. All pumps with tubing connections come with the following items (except for LMH8, LPH8, HV Series pumps): 4' Suction, 4' Return, 8' discharge tubing, footvalve/strainer assy., injection valve and bleed valve.							
<b>SUFFIX CODES:</b>	XXX = No Additional Options 130 = PVDF Tubing 500 = Five Function Valve 520 = Five Function Degas Valve ITS = 15 gal. ITS Tank System CZ_XXX = CE Approval (CZXXX=Europe; CZUKXXX=UK; CZSUIXXX=Switzerland/Liechtenstein)						
See pages 8 & 9 for additional information and specs.							

A completed model number should look like 'LS02S4-PTC1-XXX'

## Dimensions

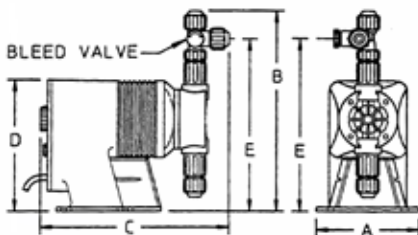

Series E-DC Dimensions (inches)						
Model No.	A	B	C	D	E	Shipping Weight
LS02	5.0	9.6	9.6	6.5	8.2	10
LS13	5.0	9.9	9.5	6.5	8.5	10
LS14	5.0	9.9	9.5	6.5	8.5	10
LS44	5.0	10.6	11.4	7.5	9.2	15

NOTE: Inches X 2.54 = cm

# PULSAtron® Electronic Metering Pumps

## Series A PLUS

### Key Features

- Manual Control by on-line adjustable stroke rate and stroke length.
- Agency approved for demanding OUTDOOR and indoor applications.
- Highly Reliable timing circuit.
- Water Resistant excellent for OUTDOOR and indoor applications.
- Internally Dampened To Reduce Noise, very acceptable for household installations.
- Guided Ball Check Valve Systems, to reduce back flow and enhance outstanding priming characteristics.
- Premium Standard Wetted Component Materials.
- Few Moving Parts and Wall Mountable.
- Safe & Easy Priming with durable leak-free bleed valve assembly (standard).
- Optional Control:
  - External pace with auto/manual selection.
  - External stop function
  - 1000:1 turndown control (S2, S3 & S4 sizes only)



Tested and Certified by WQA  
against NSF/ANSI 61 & 372.



PVDF and Degassing Head Pumps.  
See [www.wqa.org](http://www.wqa.org) for  
certification parameters.

### Engineering Data

Reproducibility:	+/- 3% at maximum capacity
Viscosity Max CPS :	1000 CPS
Stroke Frequency Max SPM:	125 / 250 by Model
Stroke Frequency Turn-Down Ratio:	10:1 / 100:1 by Model
Stroke Length Turn-Down Ratio:	10:1
Power Input:	115 VAC/50-60 HZ/1 ph 230 VAC/50-60 HZ/1 ph
Average Current Draw:	
@ 115 VAC; Amps:	0.6 Amps
@ 230 VAC; Amps:	0.3 Amps
Peak Input Power:	130 Watts
Average Input Power @ Max SPM:	50 Watts

### Pressure and Flow Rate Capacity

MODEL		LBC2	LB02	LBC3	LB03	LB04	LB64	LBC4	LBS2	LBS3	LBS4	
Capacity nominal (max.)	GPH	0.25	0.25	0.42	0.50	1.00	1.25	2.00	0.50	1.38	2.42	
	GPD	6	6	10	12	24	30	48	12	33	58	
	LPH	0.9	0.9	1.6	1.9	3.8	4.7	7.6	1.9	5.2	9.14	
Pressure <sup>1</sup> (max.)	GFPP, PVDF, 316SS or PVC (W code) w/TFE Seats	250 (17)	150 (10)	250 (17)	150 (10)	100 (7)	100 (7)	50 (3.3)	250 (17)	150 (10)	100 (7)	
	PVC (V code) Viton or CSPE Seats / Degass Liquid End	150 (10)							150 (10)			
Connections	Tubing	1/4" ID X 3/8" OD						3/8" ID X 1/2" OD		1/4" ID X 3/8" OD		
	Piping	1/4" FNPT										
Strokes/Minute	SPM	125								250		

Note 1: Pumps with rated pressure above 150 PSI will be de-rated to 150 PSI Max. when selecting certain valve options, see Price Book for details.

## Pulsatron Series A Plus Selection Guide

### Models

Product Code	Flow Rate			Pressure Rating <sup>1</sup>		Stroke Rate (SPM)	Standard Valve Size	Max. Viscosity (cps)
	GPD	GPH	LPH	PSI	BAR			
S2	12	0.50	1.9	250	17	250	J (TFE Only)	1,000
S3	33	1.38	5.2	150	10			
S4	58	2.42	9.1	100	7			
C2	6	0.25	0.9	250	17	125	J (TFE only)	
C3	10	0.42	1.6					
02	6	0.25	0.9	150	10			
03	12	0.50	1.9	100	7	1	3	
04	24	1.00	3.8					
64	30	1.25	4.7	50	3.3			

### Controls

S	Manual Control	100:1 Turndown	10:1 Stroke Length 10:1 Frequency
E	External Pace w/ Auto/Manual Switch		
P	Stop Function Option		
Q	External Pace w/ Stop (125 SPM only)		
X	Manual Control (S2, S3 & S4 sizes only)	1000:1 Turndown	10:1 Stroke Length 100:1 Frequency

### Electrical

A	115 VAC, 60Hz
B	230 VAC, 50-60Hz, 1 Ph, 6' (2m) cord with 3 prong US plug
1	115 VAC, 60Hz less Agency Approvals
2	230 VAC, 50-60Hz, 1 Ph, 6' (2m) cord, no plug, less Agency

### Liquid End Configuration - Head & Valves / Seats & O-Rings / Check Balls

PHC	GFPPL / CSPE / Ceramic (150 PSI Max) <sup>1</sup>
PTC	GFPPL / TFE / Ceramic
VTC	PVC / TFE / Ceramic (150 PSI Max) <sup>1</sup>
WTC	PVC / TFE / Ceramic (models > 150 PSI Max); For use on S2, C2, C3
KTC	PVDF / TFE / Ceramic
VVC	PVC / Viton / Ceramic (Not available with J Valve) (150 PSI Max) <sup>1</sup>
VHC	PVC / CSPE / Ceramic (Not available with J Valve) (150 PSI Max) <sup>1</sup>
Other	See Page 6 for additional materials of construction

### Connection Sizes

J	Tubing .25" I.D. x .38" O.D. Standard for pumps from 0 - 33 GPD
1	Tubing .25" I.D. x .38" O.D. Standard for pumps from 20 - 45 GPD
3	Tubing .38" I.D. x .50" O.D. Standard for pumps from 45 - 240 GPD
9	Degas Head: Vent Tubing .25" I.D. x .38" O.D. (0-150 PSI pumps only)
Metric	
R	G 1/2 A Threads, .25" Ball, 0-7.1 LPH
Y	Tubing 9 x 12mm, .25" Ball, 0-7.1 LPH
Other	See Page 7 for additional connection options

### Options

XXX	Standard Pump - No Options
130	PVDF Tubing
500	Five Function Valve
520	Five Function Degassing Valve
ITS	15 gal. ITS Tank System
CZ XXX	CE Approval (CZXXX=Europe; CZUKXXX=UK; CZSUIXXX=Switzerland/Liechtenstein)

A completed model number should look like 'LB03SA-PTCJ-XXX'

Note 1: Pumps with rated pressure above 150 PSI will be de-rated to 150 PSI Max. when selecting these valve options.

## Dimensions

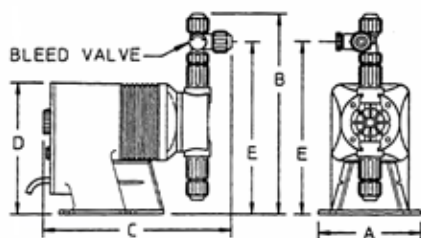

Series A PLUS Dimensions (inches)						
Model No.	A	B	C	D	E	Shipping Weight
LB02 / S2	5.0	9.6	9.5	6.5	8.2	10
LBC2	5.0	9.9	9.5	6.5	8.5	10
LBC3	5.0	9.9	9.5	6.5	8.5	10
LB03 / S3	5.0	9.9	9.5	6.5	8.5	10
LB04 / S4	5.0	9.9	9.5	6.5	8.5	10
LB64	5.0	9.9	9.5	6.5	8.5	10
LBC4	5.0	9.9	9.5	6.5	8.5	10

NOTE: Inches X 2.54 = cm

# PULSAtron® Electronic Metering Pumps

## Series T7

### Feed Control with 7 Day Timer

The Series T7 was designed to feed chemical products on a timed schedule. Typical applications include the feed of biocides in open-air cooling towers. The feed cycle is initiated and controlled by the programmable timer. The Series T7 provides everything you need in one unique, compact package to create a simple and cost effective metering system for timed applications.

### Principal of Operation

The Series T7 is controlled by a 7-day programmable timer. The timer is programmable in 1-minute increments with up to 8 on/off cycles per day. Each timed event can be set to run any day of the week on a 7-day cycle. Other control features include a standby mode, continuous 'ON' mode and the ability to adjust the stroke length from 0 – 100%.

### Features

- Isolated from Earth Ground
- Mode Select Knob, Stroke Length
- 12, 22, 30 & 44 GPD @ 100 psi – 7 bar
- Stroke length adjust 0-100%. Turn down ratio 10:1

### Engineering Data

Reproducibility:	+/- 3% at maximum capacity
Stroke Length Turn-Down Ratio:	10:1
Power Input:	115 VAC/50-60 HZ/1 ph 230 VAC/50-60 HZ/1 ph
Average Current Draw:	
@ 115 VAC; Amps:	0.6 Amps
@ 230 VAC; Amps:	0.3 Amps



Tested and Certified by WQA against NSF/ANSI 61 & 372.



PVDF and Degassing Head Pumps.  
See [www.wqa.org](http://www.wqa.org) for certification parameters.

### Pressure and Flow Rate Capacity

MODEL		LC13BA	LC14BA	LC64BA	LC44BA
Capacity nominal (max.)	GPH	0.50	1.00	1.25	2.00
	GPD	12	24	30	48
	LPH	1.9	3.8	4.7	7.6
Pressure (max.)	PSIG	100	100	100	50
	BAR	7	7	7	3.3



7-Day Timer

Solid-state 7-day electronic timer for easy adjustment of metering schedules and feed rates. Manual control allows for easy priming and start-up. The timer is programmable in 1 minute increments, with up to 8 events per day.

**PULSAtron Series T7 Selection Guide**

<b>MODELS:</b>	<b>13</b>	= 0.50 gph / 12 gpd (1.9 lph) max pres.: 100 PSI (7 BAR)
	<b>14</b>	= 1.00 gph / 24 gpd (3.8 lph) max pres.: 100 PSI (7 BAR)
	<b>64</b>	= 1.25 gph / 30 gpd (4.7 lph) max pres.: 100 PSI (7 BAR)
	<b>44</b>	= 2.00 gph / 48 gpd (7.6 lph) max pres.: 50 PSI (3.3 BAR)

<b>CONTROLS:</b>	<b>B</b>	= No Options Available
------------------	----------	------------------------

<b>ELECTRICAL:</b>	<b>A</b>	= 115 Volt / 50-60Hz
	<b>1</b>	= 115 Volt / 50-60Hz (without agency approvals)
	<b>B</b>	= 230 Volt / 50-60Hz / 1ph with 6' (1.8m) 3-wire US Plug
	<b>2</b>	= 230 Volt / 50-60Hz (without agency approvals)

<b>LIQUID END MATERIALS:</b>	<b>PHC</b>	= GFPPL / CSPE / Ceramic
	<b>PTC</b>	= GFPPL / TFE / Ceramic
Pump Head & Fittings/Seats & O-rings/Balls	<b>KTC</b>	= PVDF / TFE / Ceramic
	<b>VHC</b>	= PVC / CSPE / Ceramic
	<b>VTC</b>	= PVC / TFE / Ceramic

See page 6 for additional liquid end materials.

<b>CONNECTION SIZES:</b>	<b>1</b>	= Tubing .25" I.D. x .38" O.D. / .25" Ball, 0 - 1.88 GPH
	<b>9</b>	= Degas Head: .25" I.D. x .38" O.D. / 0-1.83 GPH
	<b>J</b>	= Tubing, .25" I.D. x .38" O.D. / .19 Ball; 0 - 1.04 GPH
	<b>METRIC:</b>	
	<b>Y</b>	= 9 x 12mm, .25" Ball, 0 - 7.10 LPH
	<b>T</b>	= 6 x 8mm, Degassing (Note: has 8 mm suction), 0 - 7.10 LPH

Please Refer to page 7 for additional connection sizes. All pumps with tubing connections come with the following items (except for LMH8, LPH8, HV Series pumps): 4' Suction, 4' Return, 8' discharge tubing, footvalve/strainer assy., injection valve and bleed valve.

<b>SUFFIX CODES:</b>	<b>XXX</b>	= No Additional Options
	<b>130</b>	= PVDF Tubing
	<b>500</b>	= Five Function Valve
	<b>520</b>	= Five Function Degas Valve
	<b>ITS</b>	= 15 gal. ITS Tank System

See pages 8 & 9 for additional information and specs.

A completed model number should look like 'LC13BA-PTC1-XXX'

**Dimensions**

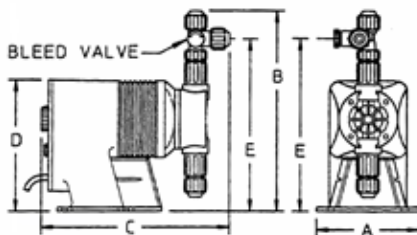

Series T7 Dimensions (inches)						
Model No.	A	B	C	D	E	Shipping Weight
LC13BA	5.0	9.6	9.5	6.5	8.2	10
LC14BA	5.0	9.9	9.5	6.5	8.5	10
LC64BA	5.0	9.9	9.5	6.5	8.5	10
LC44BA	5.4	10.6	11.3	7.4	9.2	11.8

NOTE: Inches X 2.54 = cm

# PULSAtron® Electronic Metering Pumps

## Series C PLUS

### Key Features

- Manual Control by on-line adjustable stroke rate and stroke length.
- Agency approved for demanding OUTDOOR and indoor applications.
- Highly Reliable timing circuit.
- Water Resistant excellent for OUTDOOR and indoor applications.
- Internally Dampened To Reduce Noise, very acceptable for household installations.
- Guided Ball Check Valve Systems, to reduce back flow and enhance outstanding priming characteristics.
- Premium Standard Wetted Component Materials.
- Few Moving Parts and Wall Mountable.
- Safe & Easy Priming with durable leak-free bleed valve assembly (standard).
- Optional Control: External pace with auto/manual selection.



Tested and Certified by WQA  
against NSF/ANSI 61 & 372.



PVDF and Degassing Head Pumps.  
See [www.wqa.org](http://www.wqa.org) for  
certification parameters.

### Engineering Data

Reproducibility:	+/- 3% at maximum capacity
Viscosity Max CPS :	1000 CPS
Stroke Frequency Max SPM:	125
Stroke Frequency Turn-Down Ratio:	10:1
Stroke Length Turn-Down Ratio:	10:1
Power Input:	115 VAC/50-60 HZ/1 ph 230 VAC/50-60 HZ/1 ph
Average Current Draw:	
@ 115 VAC; Amps:	0.6 Amps
@ 230 VAC; Amps:	0.3 Amps
Peak Input Power:	130 Watts
Average Input Power @ Max SPM:	50 Watts

### Pressure and Flow Rate Capacity

MODEL		LD02	LD03	LD04	LD54
Capacity nominal (max.)	GPH	0.25	0.50	1.00	1.25
	GPD	6	12	24	30
	LPH	0.9	1.9	3.8	4.7
Pressure (max.)	PSIG	80	80	80	80
	BAR	5.6	5.6	5.6	5.6
Connections	Tubing	1/4" ID X 3/8" OD			
		3/8" ID X 1/2" OD			
	Piping	1/4" FNPT			



### PULSAtron Series C Plus Selection Guide

<b>MODELS:</b>	<b>02</b>	= 0.25 gph / 6 gpd (0.9 lph) max pres.: 80 PSI (5.6 BAR)
	<b>03</b>	= 0.50 gph / 12 gpd (1.9 lph) max pres.: 80 PSI (5.6 BAR)
	<b>04</b>	= 1.00 gph / 24 gpd (3.8 lph) max pres.: 80 PSI (5.6 BAR)
	<b>54</b>	= 1.25 gph / 30 gpd (4.7 lph) max pres.: 80 PSI (5.6 BAR)

<b>CONTROLS:</b>	<b>S</b>	= Manual
	<b>E</b>	= External Pacing w/ Auto/Manual Switch
	<b>G</b>	= External Pacing w/ Prime Button
	<b>P</b>	= Stop Function Option

<b>ELECTRICAL:</b>	<b>A</b>	= 115 Volt / 50-60Hz
	<b>1</b>	= 115 Volt / 50-60Hz (without agency approvals)
	<b>B</b>	= 230 Volt / 50-60Hz / 1ph with 6' (1.8m) 3-wire US Plug
	<b>2</b>	= 230 Volt / 50-60Hz (without agency approvals)

<b>LIQUID END MATERIALS:</b>	<b>PHC</b>	= GFPP / CSPE / Ceramic
Pump Head & Fittings/Seats & O-rings/Balls	<b>PTC</b>	= GFPP / TFE / Ceramic
	<b>KTC</b>	= PVDF / TFE / Ceramic
	<b>VHC</b>	= PVC / CSPE / Ceramic
	<b>VTC</b>	= PVC / TFE / Ceramic

See page 6 for additional liquid end materials.

<b>CONNECTION SIZES:</b>	<b>1</b>	= Tubing .25" I.D. x .38" O.D. / .25" Ball, 0 - 1.88 GPH
	<b>A</b>	= Tubing .38" I.D. x .50" O.D. / .25" Ball, 0 - 1.88 GPH
	<b>J</b>	= Tubing .25" I.D. x .38" O.D. / .19" Ball; 0 - 1.04 GPH
	<b>METRIC:</b>	
	<b>R</b>	= G 1/2 A Threads, .25" Ball, 0 - 7.10 LPH
	<b>Y</b>	= 9 x 12mm, .25" Ball, 0 - 7.10 LPH

Please Refer to page 7 for additional connection sizes. All pumps with tubing connections come with the following items (except for LMH8, LPH8, HV Series pumps): 4' Suction, 4' Return, 8' discharge tubing, footvalve/strainer assy., injection valve and bleed valve.

<b>SUFFIX CODES:</b>	<b>XXX</b>	= No Additional Options
	<b>130</b>	= PVDF Tubing
	<b>500</b>	= Five Function Valve
	<b>520</b>	= Five Function Degas Valve
	<b>ITS</b>	= 15 gal. ITS Tank System
	<b>CZ_XXX</b>	= CE Approval (CZXXX=Europe; CZUKXXX=UK; CZSUIXXX=Switzerland/Liechtenstein)

See pages 8 & 9 for additional information and specs.

A completed model number should look like 'LD03SA-PTC1-XXX'

### Dimensions

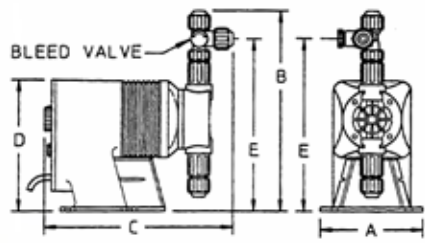

Series C PLUS Dimensions (inches)						
Model No.	A	B	C	D	E	Shipping Weight
LD02	5.0	9.6	9.5	6.5	8.2	10
LD03	5.0	9.9	9.5	6.5	8.5	10
LD04	5.0	9.9	9.5	6.5	8.5	10
LD54	5.0	9.9	9.5	6.5	8.5	10

NOTE: Inches X 2.54 = cm

# PULSAtron® Electronic Metering Pumps

## Series C

### Key Features

- Automatic Control by external pacing with prime switch (optional).
- Manual Control by on-line adjustable stroke length (fixed stroke rate).
- Liquid Low Level Option available to prevent loss of prime.
- Agency approved for demanding OUTDOOR and indoor applications.
- Highly Reliable timing circuit.
- Water Resistant excellent for OUTDOOR and indoor applications.
- Internally Dampened To Reduce Noise, very acceptable for household installations.
- Guided Ball Check Valve Systems, to reduce back flow and enhance outstanding priming characteristics.
- Premium Standard Wetted Component Materials.
- Few Moving Parts and Wall Mountable.
- Safe & Easy Priming with durable leak-free bleed valve assembly (standard).



Tested and Certified by WQA  
against NSF/ANSI 61 & 372.



PVDF and Degassing Head Pumps.  
See [www.wqa.org](http://www.wqa.org) for  
certification parameters.

### Engineering Data

Reproducibility:	+/- 3% at maximum capacity
Viscosity Max CPS :	1000 CPS
Stroke Frequency Max SPM:	125
Stroke Length Turn-Down Ratio:	10:1
Power Input:	115 VAC/50-60 HZ/1 ph 230 VAC/50-60 HZ/1 ph
Average Current Draw:	
@ 115 VAC; Amps:	0.6 Amps
@ 230 VAC; Amps:	0.3 Amps
Peak Input Power:	130 Watts
Average Input Power @ Max SPM:	50 Watts

### Pressure and Flow Rate Capacity

MODEL		LC02	LC03	LC04	LC54
Capacity nominal (max.)	GPH	0.25	0.50	1.00	1.25
	GPD	6	12	24	30
	LPH	0.9	1.9	3.8	4.7
Pressure (max.)	PSIG	80	80	80	80
	BAR	5.6	5.6	5.6	5.6
Connections	Tubing	1/4" ID X 3/8" OD 3/8" ID X 1/2" OD			
	Piping	1/4" FNPT			

### PULSAtron Series C Selection Guide

<b>MODELS:</b>	02	= 0.25 gph / 6 gpd (0.9 lph) max pres.: 80 PSI (5.6 BAR)	LC					
	03	= 0.50 gph / 12 gpd (1.9 lph) max pres.: 80 PSI (5.6 BAR)						
	04	= 1.00 gph / 24 gpd (3.8 lph) max pres.: 80 PSI (5.6 BAR)						
	54	= 1.25 gph / 30 gpd (4.7 lph) max pres.: 80 PSI (5.6 BAR)						

<b>CONTROLS:</b>	S	= Manual						
	E	= External Pacing w/ Auto/Manual Switch						
	G	= External Pacing w/ Prime Button						
	P	= Stop Function Option						

<b>ELECTRICAL:</b>	A	= 115 Volt / 50-60Hz						
	1	= 115 Volt / 50-60Hz (without agency approvals)						
	B	= 230 Volt / 50-60Hz / 1ph with 6' (1.8m) 3-wire US Plug						
	2	= 230 Volt / 50-60Hz (without agency approvals)						

<b>LIQUID END MATERIALS:</b>	PHC	= GFPP / CSPE / Ceramic						
	PTC	= GFPP / TFE / Ceramic						
Pump Head & Fittings/Seats & O-rings/Balls	VHC	= PVC / CSPE / Ceramic						
	VTC	= PVC / TFE / Ceramic						
	VVC	= PVC / Viton / Ceramic						

See page 6 for additional liquid end materials.

<b>CONNECTION SIZES:</b>	1	= Tubing .25" I.D. x .38" O.D. / .25" Ball, 0 - 1.88 GPH						
	A	= Tubing .38" I.D. x .50" O.D. / .25" Ball, 0 - 1.88 GPH						
	J	= Tubing .25" I.D. x .38" O.D. / .19 Ball; 0 - 1.04 GPH						
	<b>METRIC:</b>							
	P	= 4 x 6mm, .25" Ball, 0 - 3.94 LPH						
	U	= 6 x 8mm, .25" Ball, 0 - 7.10 LPH						

Please Refer to page 7 for additional connection sizes. All pumps with tubing connections come with the following items (except for LMH8, LPH8, HV series pumps): 4' Suction, 4' Return, 8' discharge tubing, footvalve/strainer assy., injection valve and bleed valve.

  

<b>SUFFIX CODES:</b>	XXX	= No Additional Options						
	130	= PVDF Tubing						
	500	= Five Function Valve						
	520	= Five Function Degas Valve						
	ITS	= 15 gal. ITS Tank System						
	CZ_XXX	= CE Approval (CZXXX=Europe; CZUKXXX=UK; CZSUIXXX=Switzerland/Liechtenstein)						

See pages 8 & 9 for additional information and specs.

A completed model number should look like 'LC03SA-PTC1-XXX'

## Dimensions

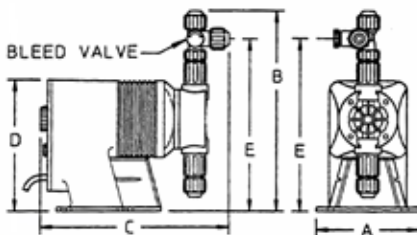

Series C Dimensions (inches)						
Model No.	A	B	C	D	E	Shipping Weight
LC02	5.0	9.6	9.5	6.5	8.2	10
LC03	5.0	9.9	9.5	6.5	8.5	10
LC04	5.0	9.9	9.5	6.5	8.5	10
LC54	5.0	9.9	9.5	6.5	8.5	10

NOTE: Inches X 2.54 = cm

# PULSAtron® KOPkit

## Selecting a KOPkit:

All KOPkit model strings begin with the letter K. The remainder of the string can be determined by knowing your pump model.

When you select your KOPkit, you will need to build the model number based on the pump model string that you purchased. The two pieces of information you need are the head size and the wet-end code, which is part of the model string of the pump.

The pump head size is the fourth digit in the pump model number.

**LB02SA-PTC1-XXX**

 The 2 represents your pump head size.

Digits 7-20 in the pump model string represent the wet-end code. It is the group of four digits set apart by the dash lines.

**LB02SA-PTC1-XXX**

 These four digits represent your wet-end code.

In the following selection guide, you will break down your wet-end code into the four parts to get your total price for the KOPkit. The four digits in the wet-end code represent the Head Material, Seats & O-Rings, Ball Material and Connection Type. Using the above example, the code breaks down as follows:

**P** - Head Material, including fittings. In this example, the P represents GFPPL.

**T** - Seat & O-Ring Material. In this example, the T represents Teflon.

**C** - Types of Balls used in the valves. In this example, the C represents Ceramic.

**1** - Connection type. In this example, the 1 represents tubing connections for 3/8" OD tubing.

The completed KOPkit number for the above example is:

**K2PTC1**

Note: If you do not find your connection size in the following selection guide, please consult the factory for accurate pricing. Our philosophy with the PULSAtron product line is to make it as flexible as our customers need it to be.

## PULSAtron KOPkit Selection Guide

		K																																																																																																																															
<b>HEAD SIZE</b>	2 = 3 = 4 = 5 = 6 = 7 = 8 = (Applies to WTCB only-for other options Consult factory)																																																																																																																																
<b>HEAD MATERIALS</b>	A = 316 Stainless Steel K = PVDF (Kynar) P = GPPPL (Polypropylene) V = PVC (Poly Vinyl Chloride) (models <= 150 psi excluding H7, H8, K7) W = PVC (models > 150 psi and H7, H8, K7)																																																																																																																																
<b>SEATS/O-RINGS</b>	H = CSPE V = Viton T = TFE																																																																																																																																
<b>BALLS</b>	T = TFE C = Ceramic S = 316 Stainless Steel H = Alloy C (Hastelloy)																																																																																																																																
<b>CONNECTION TYPE</b>	<table border="1"> <thead> <tr> <th>Type</th> <th>Suction</th> <th>Discharge</th> <th>Spring</th> </tr> </thead> <tbody> <tr><td>1 = Tubing</td><td>.25" x .38"</td><td>.25" x .38"</td><td></td></tr> <tr><td>2 = Piping</td><td>.25" FNPT</td><td>.25" FNPT</td><td></td></tr> <tr><td>3 = Tubing</td><td>.38" x .50"</td><td>.38" x .50"</td><td></td></tr> <tr><td>4 = Piping</td><td>.25" FNPT</td><td>.25" FNPT</td><td></td></tr> <tr><td>5 = Tubing</td><td>.50" x .75"</td><td>.38" x .50"</td><td>Yes</td></tr> <tr><td>6 = Piping</td><td>.25" FNPT</td><td>.25" FNPT</td><td>Yes</td></tr> <tr><td>7 = Tubing</td><td>.50" x .75"</td><td>.50" FNPT</td><td>Yes</td></tr> <tr><td>8 = Piping</td><td>.50" FNPT</td><td>.50" FNPT</td><td>Yes</td></tr> <tr><td>9 = Tubing</td><td>.25" x .38"</td><td>.25" x .38"</td><td>Yes Degas</td></tr> <tr><td>A = Tubing</td><td>.38" x .50"</td><td>.38" x .50"</td><td></td></tr> <tr><td>B = Tubing</td><td>.50" x .75"</td><td>.50" x .75"</td><td></td></tr> <tr><td>C = Piping</td><td>.50" FNPT</td><td>.50" FNPT</td><td></td></tr> <tr><td>D = Tubing</td><td>.25" x .38"</td><td>.25" x .38"</td><td>Yes</td></tr> <tr><td>E = Tubing</td><td>.38" x .50"</td><td>.38" x .50"</td><td>Yes</td></tr> <tr><td>F = Tubing</td><td>.38" x .50"</td><td>.38" x .50"</td><td>Yes</td></tr> <tr><td>G = Piping</td><td>.25" FNPT</td><td>.25" FNPT</td><td>Yes</td></tr> <tr><td>I = Piping</td><td>.50" MNPT</td><td>.50" MNPT</td><td>Yes</td></tr> <tr><td>J = Tubing</td><td>.25" x .38"</td><td>.25" x .38"</td><td></td></tr> <tr><td>K = Tubing</td><td>.50" x .75"</td><td>.50" x .75"</td><td>Yes</td></tr> <tr><td>L = Piping</td><td>.50" MNPT</td><td>.50" MNPT</td><td></td></tr> <tr><td>M = Piping</td><td>G 1/2 A</td><td>G 1/2 A</td><td></td></tr> <tr><td>P = Tubing</td><td>4 x 6 mm</td><td>4 x 6 mm</td><td></td></tr> <tr><td>R = Piping</td><td>G 1/2 A</td><td>G 1/2 A</td><td></td></tr> <tr><td>S = Tubing</td><td>6 x 8 mm</td><td>6 x 8 mm</td><td></td></tr> <tr><td>T = Tubing</td><td>6 x 8 mm</td><td>6 x 8 mm</td><td>Yes Degas</td></tr> <tr><td>U = Tubing</td><td>6 x 8 mm</td><td>6 x 8 mm</td><td></td></tr> <tr><td>V = Tubing</td><td>12 x 19 mm</td><td>12 x 19 mm</td><td></td></tr> <tr><td>W = Tubing</td><td>8 x 12 mm</td><td>8 x 12 mm</td><td></td></tr> <tr><td>Y = Tubing</td><td>9 x 12 mm</td><td>9 x 12 mm</td><td></td></tr> <tr><td>X = Piping</td><td>.50" MNPT</td><td>.50" MNPT</td><td></td></tr> </tbody> </table>	Type	Suction	Discharge	Spring	1 = Tubing	.25" x .38"	.25" x .38"		2 = Piping	.25" FNPT	.25" FNPT		3 = Tubing	.38" x .50"	.38" x .50"		4 = Piping	.25" FNPT	.25" FNPT		5 = Tubing	.50" x .75"	.38" x .50"	Yes	6 = Piping	.25" FNPT	.25" FNPT	Yes	7 = Tubing	.50" x .75"	.50" FNPT	Yes	8 = Piping	.50" FNPT	.50" FNPT	Yes	9 = Tubing	.25" x .38"	.25" x .38"	Yes Degas	A = Tubing	.38" x .50"	.38" x .50"		B = Tubing	.50" x .75"	.50" x .75"		C = Piping	.50" FNPT	.50" FNPT		D = Tubing	.25" x .38"	.25" x .38"	Yes	E = Tubing	.38" x .50"	.38" x .50"	Yes	F = Tubing	.38" x .50"	.38" x .50"	Yes	G = Piping	.25" FNPT	.25" FNPT	Yes	I = Piping	.50" MNPT	.50" MNPT	Yes	J = Tubing	.25" x .38"	.25" x .38"		K = Tubing	.50" x .75"	.50" x .75"	Yes	L = Piping	.50" MNPT	.50" MNPT		M = Piping	G 1/2 A	G 1/2 A		P = Tubing	4 x 6 mm	4 x 6 mm		R = Piping	G 1/2 A	G 1/2 A		S = Tubing	6 x 8 mm	6 x 8 mm		T = Tubing	6 x 8 mm	6 x 8 mm	Yes Degas	U = Tubing	6 x 8 mm	6 x 8 mm		V = Tubing	12 x 19 mm	12 x 19 mm		W = Tubing	8 x 12 mm	8 x 12 mm		Y = Tubing	9 x 12 mm	9 x 12 mm		X = Piping	.50" MNPT	.50" MNPT					
Type	Suction	Discharge	Spring																																																																																																																														
1 = Tubing	.25" x .38"	.25" x .38"																																																																																																																															
2 = Piping	.25" FNPT	.25" FNPT																																																																																																																															
3 = Tubing	.38" x .50"	.38" x .50"																																																																																																																															
4 = Piping	.25" FNPT	.25" FNPT																																																																																																																															
5 = Tubing	.50" x .75"	.38" x .50"	Yes																																																																																																																														
6 = Piping	.25" FNPT	.25" FNPT	Yes																																																																																																																														
7 = Tubing	.50" x .75"	.50" FNPT	Yes																																																																																																																														
8 = Piping	.50" FNPT	.50" FNPT	Yes																																																																																																																														
9 = Tubing	.25" x .38"	.25" x .38"	Yes Degas																																																																																																																														
A = Tubing	.38" x .50"	.38" x .50"																																																																																																																															
B = Tubing	.50" x .75"	.50" x .75"																																																																																																																															
C = Piping	.50" FNPT	.50" FNPT																																																																																																																															
D = Tubing	.25" x .38"	.25" x .38"	Yes																																																																																																																														
E = Tubing	.38" x .50"	.38" x .50"	Yes																																																																																																																														
F = Tubing	.38" x .50"	.38" x .50"	Yes																																																																																																																														
G = Piping	.25" FNPT	.25" FNPT	Yes																																																																																																																														
I = Piping	.50" MNPT	.50" MNPT	Yes																																																																																																																														
J = Tubing	.25" x .38"	.25" x .38"																																																																																																																															
K = Tubing	.50" x .75"	.50" x .75"	Yes																																																																																																																														
L = Piping	.50" MNPT	.50" MNPT																																																																																																																															
M = Piping	G 1/2 A	G 1/2 A																																																																																																																															
P = Tubing	4 x 6 mm	4 x 6 mm																																																																																																																															
R = Piping	G 1/2 A	G 1/2 A																																																																																																																															
S = Tubing	6 x 8 mm	6 x 8 mm																																																																																																																															
T = Tubing	6 x 8 mm	6 x 8 mm	Yes Degas																																																																																																																														
U = Tubing	6 x 8 mm	6 x 8 mm																																																																																																																															
V = Tubing	12 x 19 mm	12 x 19 mm																																																																																																																															
W = Tubing	8 x 12 mm	8 x 12 mm																																																																																																																															
Y = Tubing	9 x 12 mm	9 x 12 mm																																																																																																																															
X = Piping	.50" MNPT	.50" MNPT																																																																																																																															



# PULSAtron® KOPkit

PULSAtron KOPkit	
Part Number	Description
K2ATC2	KOPKIT K2 316/TFE/CDBL .25N
K2ATCG	KOPKIT K2 316/TFE/CSPR .25N
K2KTC1	KOPKIT K2 PVD/TFE/CDBL .38T
K2KTCJ	KOPKIT K2 PVD/TFE/CDBL .38T
K2PHC1	KOPKIT K2 FPP/HYP/C .38T
K2PTC1	KOPKIT K2 FPP/TFE/CDBL .38T
K2PTC2	KOPKIT K2 FPP/TFE/CDBL .25N
K2PTCJ	KOPKIT K2 FPP/TFE/CDBL .38T
K2VAT1	KOPKIT K2 PVC/HYP/TDBL .38T
K2VHC1	KOPKIT K2 PVC/HYP/C .38T
K2VTC1	KOPKIT K2 PVC/TFE/CDBL .38T
K2VTC9	KOPKIT K2 PVC/TFE/CDBL .38T
K2VTCJ	KOPKIT K2 PVC/TFE/CDBL .38T
K2VVC1	KOPKIT K2 PVC/VTN/C .38T
K2VVC9	KOPKIT K2 PVC/VTN/C .38T
K2WTC1	KOPKIT K2 HPV/TFE/CDBL .38T
K2WTCJ	KOPKIT K2 HPV/TFE/CDBL .38T
K3ATC2	KOPKIT K3 316/TFE/CDBL .25N
K3ATSG	KOPKIT K3 316/TFE/SSPR .25N
K3KTC1	KOPKIT K3 PVD/TFE/CDBL .38T
K3KTCA	KOPKIT K3 PVD/TFE/CDBL .50T
K3KTCJ	KOPKIT K3 PVD/TFE/CDBL .38T
K3KTT1	KOPKIT K3 PVD/TFE/TDBL .38T
K3PHC1	KOPKIT K3 FPP/HYP/C .38T
K3PTC1	KOPKIT K3 FPP/TFE/CDBL .38T
K3PTC2	KOPKIT K3 FPP/TFE/CDBL .25N
K3PTCJ	KOPKIT K3 FPP/TFE/CDBL .38T
K3PTT1	KOPKIT K3 FPP/TFE/TDBL .38T
K3PTT5	KOPKIT K3 FPP/TFE/TSPR .50T
K3VHC1	KOPKIT K3 PVC/HYP/C .38T
K3VHC9	KOPKIT K3 PVC/HYP/C .38T
K3VTC1	KOPKIT K3 PVC/TFE/CDBL .38T
K3VTC9	KOPKIT K3 PVC/TFE/CDBL .38T
K3VTCJ	KOPKIT K3 PVC/TFE/CDBL .38T
K3VTT5	KOPKIT K3 PVC/TFE/TSPR .50T
K3VVC1	KOPKIT K3 PVC/VTN/C .38T
K3VVC9	KOPKIT K3 PVC/VTN/C .38T
K3WTC1	KOPKIT K3 HPV/TFE/CDBL .38T
K3WTCJ	KOPKIT K3 PVC/TFE/CDBL .38T
K4ATS2	KOPKIT K4 316/TFE/SDBL .25N
K4ATSG	KOPKIT K4 316/TFE/SSPR .25N
K4KTC1	KOPKIT K4 PVD/TFE/CDBL .38T
K4KTC2	KOPKIT K4 PVD/TFE/CDBL .25N
K4KTC3	KOPKIT K4 PVD/TFE/CDBL .50T
K4KTCJ	KOPKIT K4 PVD/TFE/CDBL .38T
K4KTT1	KOPKIT K4 PVD/TFE/TDBL .38T
K4KVC1	KOPKIT K4 PVD/VTN/C .38T
K4PHC1	KOPKIT K4 FPP/HYP/C .38T
K4PTC1	KOPKIT K4 FPP/TFE/CDBL .38T
K4PTC3	KOPKIT K4 FPP/TFE/CDBL .50T
K4PTCA	KOPKIT K4 FPP/TFE/CDBL .50T
K4PTCJ	KOPKIT K4 FPP/TFE/CDBL .38T
K4PTS3	KOPKIT K4 FPP/TFE/SDBL .50T
K4PTT1	KOPKIT K4 FPP/TFE/TDBL .38T
K4PTT5	KOPKIT K4 FPP/TFE/TSPR .50T
K4PVC1	KOPKIT K4 FPP/VTN/C .38T
K4PVS3	KOPKIT K4 FPP/VTN/316 .50T
K4VHC1	KOPKIT K4 PVC/HYP/C .38T
K4VHC3	KOPKIT K4 PVC/HYP/C .50T
K4VHC9	KOPKIT K4 PVC/HYP/C .38T
K4VHCA	KOPKIT K4 PVC/HYP/C .50T

Part Number	Description
K4VTC1	KOPKIT K4 PVC/TFE/CDBL .38T
K4VTC2	KOPKIT K4 PVC/TFE/CDBL .25N
K4VTC3	KOPKIT K4 PVC/TFE/CDBL .50T
K4VTC9	KOPKIT K4 PVC/TFE/CDBL .38T
K4VTCA	KOPKIT K4 PVC/TFE/CDBL .50T
K4VTCJ	KOPKIT K4 PVC/TFE/CDBL .38T
K4VTSK	KOPKIT K4 PVC/TFE/SSPR .75T
K4VTT1	KOPKIT K4 PVC/TFE/TDBL .38T
K4VTT5	KOPKIT K4 PVC/TFE/TSPR .50T
K4VVC1	KOPKIT K4 PVC/VTN/C .38T
K4VVC9	KOPKIT K4 PVC/VTN/C .38T
K4WTC1	KOPKIT K4 HPV/TFE/CDBL .38T
K4WTC3	KOPKIT K4 HPV/TFE/CDBL .50T
K5ATS4	KOPKIT K5 316/TFE/SDBL .25N
K5KTC3	KOPKIT K5 PVD/TFE/CDBL .50T
K5PHC3	KOPKIT K5 FPP/HYP/C .50T
K5PTC3	KOPKIT K5 FPP/TFE/CDBL .50T
K5PTC4	KOPKIT K5 FPP/TFE/CDBL .25N
K5PTCH	KOPKIT K5 FPP/TFE/CDBL .38T
K5PTSK	KOPKIT K5 FPP/TFE/SSPR .75T
K5PTT3	KOPKIT K5 FPP/TFE/TDBL .50T
K5VHC3	KOPKIT K5 PVC/HYP/C .50T
K5VTC3	KOPKIT K5 PVC/TFE/CDBL .50T
K5VTSK	KOPKIT K5 PVC/TFE/SSPR .75T
K5VTT4	KOPKIT K5 PVC/TFE/TDBL .25N
K5VVC3	KOPKIT K5 PVC/VTN/C .50T
K6ATS4	KOPKIT K5 316/TFE/SDBL .25N
K6KTC3	KOPKIT K6 PVD/TFE/CDBL .50T
K6KTC4	KOPKIT K6 PVD/TFE/CDBL .25N
K6KTT3	KOPKIT K6 PVD/TFE/TDBL .50T
K6PHC3	KOPKIT K6 FPP/HYP/C .50T
K6PTC3	KOPKIT K6 FPP/TFE/CDBL .50T
K6PTC4	KOPKIT K6 FPP/TFE/CDBL .25N
K6PTC7	KOPKIT K6 FPP/TFE/CSPR .50N
K6PTT3	KOPKIT K6 FPP/TFE/TDBL .50T
K6PTT4	KOPKIT K6 FPP/TFE/TDBL .25N
K6VHC3	KOPKIT K6 PVC/HYP/C .50T
K6VTC3	KOPKIT K6 PVC/TFE/CDBL .50T
K6VTT3	KOPKIT K6 PVC/TFE/TDBL .50T
K6VVC3	KOPKIT K6 PVC/VTN/C .50T
K7KTC3	KOPKIT K7 PVD/TFE/CDBL .50T
K7KTC4	KOPKIT K7 PVD/TFE/CDBL .25N
K7KTT3	KOPKIT K7 PVD/TFE/TDBL .50T
K7PHC3	KOPKIT K7 FPP/HYP/C .50T
K7PTC3	KOPKIT K7 FPP/TFE/CDBL .50T
K7PTC4	KOPKIT K7 FPP/TFE/CDBL .25N
K7PTS3	KOPKIT K7 FPP/TFE/SDBL .75T
K7PTT3	KOPKIT K7 FPP/TFE/TDBL .50T
K7WHC3	KOPKIT K7 HPV/HYP/C .50T
K7WTC3	KOPKIT K7 HPV/TFE/CDBL .50T
K7WTC8	KOPKIT K7 HPV/TFE/CSPR .50N
K7WTSK	KOPKIT K7 HPV/TFE/SSPR .75T
K7WTT3	KOPKIT K7 HPV/TFE/TDBL .50T
K8PTCB	KOPKIT K8 FPP/TFE/C .75T
K8PTCC	KOPKIT K8 FPP/TFE/C .50N
K8PTS3	KOPKIT K8 FPP/TFE/316 .75T
K8PTTB	KOPKIT K8 FPP/TFE/TFE .75T
K8WTC8	KOPKIT K8 HPV/TFE/CSPR .50N
K8WTCB	KOPKIT K8 HPV/TFE/C .75T
K8WTCC	KOPKIT K8 HPV/TFE/C .50N
K8WTTB	KOPKIT K8 HPV/TFE/TFE .75T
K8WVCB	KOPKIT K8 HPV/VTN/C .75T

### Suction and Discharge Valve Kits

Part Number	Description
VKKT1	Valve Kit - Suction & Discharge Valves - KTC1
VKKT3	Valve Kit - Suction & Discharge Valves - KTC3
VKPT1	Valve Kit - Suction & Discharge Valves - PTC1
VKPT3	Valve Kit - Suction & Discharge Valves - PTC3
VKVHC1	Valve Kit - Suction & Discharge Valves - VHC1
VKVHC3	Valve Kit - Suction & Discharge Valves - VHC3
VKVTC1	Valve Kit - Suction & Discharge Valves - VTC1
VKVTC3	Valve Kit - Suction & Discharge Valves - VTC3
VKVVC9	Valve Kit - Suction, Discharge & Degas Valves - VVC9

### Diaphragm Kits - Pack of 5 includes Diaphragm, Deflection Plate, Shims

Part Number	Description
5PKDIA2	5 Pack Diaphragm, Deflection Plate, Shims - Head # 2
5PKDIA3	5 Pack Diaphragm, Deflection Plate, Shims Head # 3
5PKDIA4	5 Pack Diaphragm, Deflection Plate, Shims Head # 4
5PKDIA5	5 Pack Diaphragm, Deflection Plate, Shims Head # 5
5PKDIA6	5 Pack Diaphragm, Deflection Plate, Shims Head # 6
5PKDIA7	5 Pack Diaphragm, Deflection Plate, Shims Head # 7
5PKDIA8	5 Pack Diaphragm, Deflection Plate, Shims Head # 8

### PEPkit - Includes KOPkit, Bleed Vlv, Injection Vlv, Foot Vlv Strainer, Tubing

Part Number	Description
P2PTC1	PEPkit P2 FPP/TFE/CDBL .38T
P2PTCJ	PEPkit P2 FPP/TFE/CDBL .38T
P3PTC1	PEPkit K3 FPP/TFE/CDBL .38T
P3VTC1	PEPKIT K3 PVC/TFE/CDBL .38T
P3VTCJ	PEPKIT K3 PVC/TFE/CDBL .38T
P4KTC1	PEPKIT K4 PVD/TFE/CDBL .38T
P4PTC1	PEPKIT K4 FPP/TFE/CDBL .38T
P4VHC1	PEPKIT K4 PVC/HYP/C .38T
P4VTC1	PEPKIT K4 PVC/TFE/CDBL .38T
P4VVC9	PEPKIT K4 PVC/VTN/C .38T
P5PTC3	PEPKIT K5 FPP/TFE/CDBL .50T
P5VTC3	PEPKIT K5 PVC/TFE/CDBL .50T
P6PTC3	PEPKIT K6 FPP/TFE/CDBL .50T
P6VTC3	PEPKIT K6 PVC/TFE/CDBL .50T
P7PTC3	PEPKIT K7 FPP/TFE/CDBL .50T
P8WTB	PEPKIT K8 HPV/TFE/C .75T

Drive End Components		
Part Number	Description	
L5000801-115	CNTRL PANEL ASSY; A-B-D-E SIZE SLDS,	115V
L5000901-115	CNTRL PANEL ASSY, EXT/STOP; A-B-D-E SIZE SLDS,	115V
L5000901-230	CNTRL PANEL ASSY, EXT/STOP; A-B-D-E SIZE SLDS,	230V
L5001001-115	CNTRL PANEL ASSY, 4-20MA/STOP; A-B-D-E- SIZE SLDS,	115V
L5001001-230	CNTRL PANEL ASSY, 4-20MA/STOP; A-B-D-E SIZE SLDS,	230V
L5001301-115	CNTRL PANEL ASSY, H SIZE SLD	115V
L5028500-115	CNTRL PANEL ASSY, LEH8	115V
L5028201-115	CNTRL PANEL ASSY, LVH7, LP/LVH8	115V
L5001401-115	CNTRL PANEL ASSY, EXT/STOP; H SIZE SLD	115V
L5001401-230	CNTRL PANEL ASSY, EXT/STOP; H SIZE SLD	230V
L5028301-115	CNTRL PANEL ASSY, EXT/STOP; LVH7, LP/LVH8	115V
L5028300-230	CNTRL PANEL ASSY, EXT/STOP; LVH7, LP/LVH8	230V
L5001501-115	CNTRL PANEL ASSY, 4-20MA/STOP; H SIZE SLD	115V
L5001501-230	CNTRL PANEL ASSY, 4-20MA/STOP; H SIZE SLD,	230V
L5028401-115	CNTRL PANEL ASSY, 4-20MA/STOP; LVH7, LP/LVH8	115V
L5028401-230	CNTRL PANEL ASSY, 4-20MA/STOP; LVH7, LP/LVH8	230V
L5000100-115	CNTRL PANEL ASSY, SERIES E; 0-1/SIZE SLD	115V
L5000100-230	CNTRL PANEL ASSY, SERIES E; 0-1/SIZE SLD	230V
L5000200-115	CNTRL PANEL ASSY, 3-4 SIZE SLDS	115V
L5000200-230	CNTRL PANEL ASSY, 3-4 ZISE SLDS	230V
L5002900-115	CNTRL PANEL ASSY SIN-FUNC; 0-SIZE SLD, SERIES C	115V
L5003000-115	CNTRL PANEL ASSY SIN-FUNC; 5-SIZE SLD, SERIES C	115V
L5011000-115	CNTRL PANEL ASSY EXT PACE; SIZE 54, SERIES C	115V
L5013000-115	CNTRL PANEL ASSY EXT PACE; SIZE 54, SERIES C	115V
L5003016-115	CNTRL PANEL ASSY, 4-20MA/STOP; LPK5	115V
L5003701-115	CNTRL PANEL ASSY, STD; K SIZE SLD	115V
L5003801-115	CNTRL PANEL ASSY, EXT/STOP; K SIZE SLD	115V
L5003801-230	CNTRL PANEL ASSY, EXT/STOP; K SIZE SLD	230V
L5003903-115	CNTRL PANEL ASSY, 4-20MA/STOP; K7	115V
L5003903-230	CNTRL PANEL ASSY, 4-20MA/STOP; K7	230V
L5004100-115	CNTRL PANEL ASSY, SIN-FUNC; SIZE 54, SERIES C PLUS	115V
L5010800-230	CNTRL PANEL ASSY EXT PACE; SIZE 02, 03, 04, C3, C4 SERIES A+/C+	230V
L5010900-230	CNTRL PANEL ASSY EXT PACE; SIZE 54, 64 SERIES A+/C+	230V
L5005200-115	CNTRL PANEL ASSY; SIZE 02, 03, 04, C3, C4 SERIES A+/C+	115V
L5005300-230	CNTRL PANEL ASSY; SIZE 02, 03, 04, C3, C4 SERIES A+/C+	230V
L5004800-115	CNTRL PANEL ASSY; SIZE 54, 64 SERIES A+/C+	115V
L5007501-115	CNTRL PNL ASSY LMK2; SIGNAL RELAY	115V
L5007301-115	CNTRL PNL ASSY LM A,B,C,D,E,K3; SIGNAL RELAY	115V
L5007301-230	CNTRL PNL ASSY LM A,B,C,D,E,K3; SIGNAL RELAY	230V
L5007401-115	CNTRL PNL ASSY LM A,B,C,D,E,K3; POWER RELAY	115V
L5007401-230	CNTRL PNL ASSY LM A,B,C,D,E,K3; POWER RELAY	230V
L5007701-115	CNTRL PNL ASSY LMK5; SIGNAL RELAY	115V
L5007101-115	CNTRL PNL ASSY LM F, G; SIGNAL RELAY	115V
L5007701-230	CNTRL PNL ASSY LMK5; SIGNAL RELAY	230V
L5007101-230	CNTRL PNL ASSY LM F, G; SIGNAL RELAY	230V
L5007801-115	CNTRL PNL ASSY LMK5; POWER RELAY	115V
L5007201-115	CNTRL PNL ASSY LM F, G; POWER RELAY	115V
L5007901-115	CNTRL PNL ASSY LMK7; SIGNAL RELAY	115V
L5006901-115	CNTRL PNL ASSY LM H; SIGNAL RELAY	115V
L5007901-230	CNTRL PNL ASSY LMK7; SIGNAL RELAY	230V
L5006901-230	CNTRL PNL ASSY LM H; SIGNAL RELAY	230V
L5007001-115	CNTRL PNL ASSY H; POWER RELAY	115V



**Bleed Valve Assemblies**

Part Number	Description	
L3300H01-FPP	FPP/CSPE	3/8"
L3300H01-PVC	PVC/CSPE	3/8"
L3300H03-FPP	FPP/CSPE	1/2"
L3300H03-PVC	PVC/CSPE	1/2"
L3300T01-FPP	FPP/TFE	3/8"
L3300T01-PVC	PVC/TFE	3/8"
L3300T01-PVD	PVD/TFE	3/8"
L3300T03-FPP	FPP/TFE	1/2"
L3300T03-PVC	PVC/TFE	1/2"
L3300T03-PVD	PVD/TFE	1/2"
L3300V01-FPP	FPP/VTN	3/8"
L3300V01-PVC	PVC/VTN	3/8"
L3300V01-PVD	PVD/VTN	3/8"
L3300V03-FPP	FPP/VTN	1/2"
L3300V03-PVC	PVC/VTN	1/2"
L3300V03-PVD	PVD/VTN	1/2"

**Foot Valve / Strainer Assemblies**

Part Number	Description	
J40117	FPP/CSPE/C	3/8" X 1/2"
J40123	FPP/CSPE/TFE	3/8" X 1/2"
J60509	FPP/VTN/C	3/8" X 1/2"
J40141	FPP/VTN/316	3/8" X 1/2"
J40125	FPP/VTN/TFE	3/8" X 1/2"
J40212	FPP/FTF/C	3/8" X 1/2"
J40175	FPP/FTF/316	3/8" X 1/2"
J40171	FPP/FTF/TFE	3/8" X 1/2"
J60728	PVD/FTF/C	3/8" X 1/2"
J60729	PVD/CSPE/C	3/8" X 1/2"
J60730	PVD/VTN/C	3/8" X 1/2"
J40116	FPP/CSPE/C	1/4" X 3/8"
J40156	FPP/CSPE/316	1/4" X 3/8"
J40122	FPP/CSPE/TFE	1/4" X 3/8"
J60524	FPP/VTN/C	1/4" X 3/8"
J40158	FPP/VTN/316	1/4" X 3/8"
J40124	FPP/VTN/TFE	1/4" X 3/8"
J40211	FPP/FTF/C	1/4" X 3/8"
J40170	FPP/FTF/316	1/4" X 3/8"
J40169	FPP/FTF/TFE	1/4" X 3/8"
J60716	PVD/FTF/C	1/4" X 3/8"
J60717	PVD/CSPE/C	1/4" X 3/8"
J60718	PVD/VTN/C	1/4" X 3/8"
J40095	316 - Strainer Only	.25 NPT
J40195	FPP/CSPE/C	.25 NPT
J40187	FPP/VTN/C	.25 NPT
J40179	FPP/FTF/C	.25 NPT
J60503	FPP - Strainer Only	.50 NPT
J60561	FPP - Strainer Only	1/2 X 3/4"
J60564	FPP/FTF/C	3/16 X 5/16"
J60712	PVD/FTF/C	3/16 X 5/16"

**Stainless Steel Valve Repair Kits**

Part Number	Description
L9904200-316	VALVE REPAIR KIT - ATS2
L9904600-316	VALVE REPAIR KIT - ATS4
L9904900-316	VALVE REPAIR KIT - ATSG

**Tubing - Per FT - Min 25 Feet**

Part Number	Description - Per Ft. Min 25 Feet
00007	SUCT, 3/8 OD, CLEAR PVC
00008	DISCH, 1/2 OD, WHITE PE
00009	DISCH, 1/2 OD, BLACK PE
00010	DISCH, 3/8 OD, WHITE PE
00011	DISCH, 3/8 OD, BLACK PE
J00012	DISCH, 1/2 OD, HI PRES, WHITE
00013	DISCH, 1/2 OD, HI PRES, BLACK
J00022	DISCH, 3/8 OD, HI PRES, WHITE
J00023	SUCT, 1/2 OD, CLEAR PVC
J00024	DISCH, 3/8 OD, HI PRES, BLACK
J00032	SUCT/DISCH, 3/4 OD, CLEAR PVC

**Injection Back Press Valve Assemblies**

Part Number	Description	
J41767	FPP/CSPE/C	3/8" X 1/2"
J41863	FPP/CSPE/316	3/8" X 1/2"
J41773	FPP/CSPE/TFE	3/8" X 1/2"
41716	FPP/VTN/C	3/8" X 1/2"
J41882	FPP/VTN/316	3/8" X 1/2"
J41775	FPP/VTN/TFE	3/8" X 1/2"
J41872	FPP/FTF/C	3/8" X 1/2"
J41879	FPP/FTF/316	3/8" X 1/2"
J41875	FPP/FTF/TFE	3/8" X 1/2"
J41694	PVC/CSPE/C	3/8" X 1/2"
41698	PVC/CSPE/C 6"	3/8" X 1/2"
41702	PP/VTN/C 6"	3/8" X 1/2"
J41865	PVC/CSPE/316	3/8" X 1/2"
J41759	PVC/CSPE/TFE	3/8" X 1/2"
J41714	PVC/VTN/C	3/8" X 1/2"
J41761	PVC/VTN/TFE	3/8" X 1/2"
J41873	PVC/FTF/C	3/8" X 1/2"
J41881	PVC/FTF/316	3/8" X 1/2"
J41877	PVC/FTF/TFE	3/8" X 1/2"
J61073	PVD/FTF/TFE	3/8" X 1/2"
J61021	PVD/FTF/C	3/8" X 1/2"
J41766	FPP/CSPE/C	1/4" X 3/8"
J41862	FPP/CSPE/316	1/4" X 3/8"
J41772	FPP/CSPE/TFE	1/4" X 3/8"
41715	FPP/VTN/C	1/4" X 3/8"
41701	FPP/VTN/C 6"	1/4" X 3/8"
J41866	FPP/VTN/316	1/4" X 3/8"
J41774	FPP/VTN/TFE	1/4" X 3/8"
J61098	FPP/FTF/C	1/4" X 3/8"
J41878	FPP/FTF/316	1/4" X 3/8"
J41874	FPP/FTF/TFE	1/4" X 3/8"
41693	PVC/CSPE/C	1/4" X 3/8"
41705	PVC/CSPE/C 6"	1/4" X 3/8"
J41758	PVC/CSPE/TFE	1/4" X 3/8"
J61237	PVC/VTN/C	1/4" X 3/8"
J41867	PVC/VTN/316	1/4" X 3/8"
41760	PVC/VTN/TFE	1/4" X 3/8"
J41996	PVC/FTF/C	1/4" X 3/8"
J41880	PVC/FTF/316	1/4" X 3/8"
J41876	PVC/FTF/TFE	1/4" X 3/8"
J61020	PVD/FTF/C	1/4" X 3/8"
J61026	PVD/FTF/TFE	1/4" X 3/8"
J41911	FPP/CSPE/C	.25 NPT
J41901	FPP/VTN/C	.25 NPT
J41944	FPP/FTF/C	.25 NPT
J41904	PVC/CSPE/C	.25 NPT
J41858	PVC/VTN/C	.25 NPT
J41908	PVC/FTF/C	.25 NPT
J61015	PVD/FTF/C	.25 NPT
J61025	316/FTF/316	.25 NPT
J41969	PVC/CSPE/C	1/2 X 3/4"
J61149-10P	FPP/FTF/C	1/2 X 3/4"
J61157-10P	PVC/FTF/C	.50 NPT
J61156-10P	PVC/TFE/S	.50 NPT

Part Number	Description - Per Ft. Min 25 Feet
L9902900-000	PVDF TUBING, 3/8 OD
L9903000-000	PVDF TUBING, 1/2 OD
L9904300-PEB	SUCT, 5/16 OD, PE BLACK
L9904300-PEW	SUCT, 5/16 OD, PE WHITE
L9904300-PVC	SUCT, 5/16 OD, CLEAR PVC
L9904300-PVD	SUCT, 5/16 OD, PVDF WHITE
L9904500-PEW	DISCH, 1/2 X 5/8, PE WHITE
L9913200-BRD	PVC CLEAR BRAIDED, 3/4 OD

# BLACK LINE

## Mechanical Diaphragm Pumps

### Series MD

#### Key Features

- Liquid End Materials – GFPPPL, 316SS & PVDF.
- Rugged double-sided PTFE faced, long life diaphragm.
- Oil Lubricated Ball Bearings in anodized aluminum housing.
- Oil sight glass for quick and easy oil level check.
- Large, easy to access oil drain port.
- Manual micrometer style stroke adjustment; 10:1 turndown, up to 100:1 with VFD Vector drive.
- Standard NEMA 56C or IEC71 motor frames available.

#### Optional Features

- Variable Frequency Drive for Automatic Control.
  - Fully Scalable 4-20mA, 0-10VDC signals.
  - NEMA 4X Enclosure.
- ATEX Group II, Category 3 – Zone 2/22 for non-flammable liquids with proper motor selection.



CE

#### Engineering Data

Reproducibility:	+/- 3% at maximum capacity
Viscosity Max CPS :	1000 CPS
Stroke Frequency Max SPM:	125
Stroke Length Turn-Down Ratio:	10:1
Power Input:	115 VAC/50-60 HZ/1 ph 230 VAC/50-60 HZ/1 ph
Average Current Draw:	
@ 115 VAC; Amps:	0.6 Amps
@ 230 VAC; Amps:	0.3 Amps
Peak Input Power:	130 Watts
Average Input Power @ Max SPM:	50 Watts

#### Pressure and Flow Rate Capacity

MODEL		MD1A	MD1B	MD1C	MD1D	MD1E	MD2F	MD2J	MD2K	MD3G
Capacity nominal (max.)	GPH	7	14	22	29	35	59	79	98	132
	LPH	26	53	83	110	132	223	299	371	500
Pressure (max.)	PSIG	150	150	150	150	150	90	90	75	75
	BAR	10	10	10	10	10	6	6	5	-5
Strokes/Minute	SPM	84	60	84	116	138	84	118	138	118
Viscosity	CPS	1000			500		1000	500		
Connections:	FNPT	1/2"					3/4"			1"
	BSPT-F	1/2"					3/4"			1"

Blackline Series MD Selection Guide		MD	---	---	---	---	---	---	---	XXX
<b>MODELS:</b>	1A = 7 gph ( 26 lph) max pres.: 150 PSI (10 BAR) 1B = 14 gph ( 53 lph) max pres.: 150 PSI (10 BAR) 1C = 22 gph ( 82 lph) max pres.: 150 PSI (10 BAR) 1D = 29 gph / ( 111 lph) max pres.: 150 PSI (10 BAR) 1E = 35 gph / ( 133 lph) max pres.: 150 PSI (10 BAR) 2F = 59 gph / ( 225 lph) max pres.: 90 PSI (6 BAR) 2J = 79 gph / (298 lph) max pres.: 90 PSI (6 BAR) 2K = 98 gph / ( 371lph) max pres.: 75 PSI (5 BAR) 3G = 132 gph / (501 lph) max pres.: 75 PSI (5 BAR)									
<b>LIQUID END Size 1A-E</b>	KTP = PVDF Head / PTFE Valve Seat / Pyrex Valve Check Ball PPP = Glass Filled Polypropylene Head / PVC Valve Seat / Pyrex Valve Check Ball AAS = 316SS Head / 316SS Valve Seat / 316SS Valve Check Ball KMM** = PVDF Head / Incoloy 825 Valve Seat / Hastelloy C-276 Valve Check Ball									
<b>Size 2F-K</b>	KTP = PVDF Head / PTFE Valve Seat / Pyrex Valve Check Ball PPP = Glass Filled Polypropylene Head / PVC Valve Seat / Pyrex Valve Check Ball AAS = 316SS Head / 316SS Valve Seat / 316SS Valve Check Ball KMM** = PVDF Head / Incoloy 825 Valve Seat / Hastelloy C-276 Valve Check Ball									
<b>Size 3G</b>	KTP = PVDF Head / PTFE Valve Seat / Pyrex Valve Check Ball PPP = Glass Filled Polypropylene Head / PVC Valve Seat / Pyrex Valve Check Ball AAS = 316SS Head / 316SS Valve Seat / 316SS Valve Check Ball KMM** = PVDF Head / Incoloy 825 Valve Seat / Hastelloy C-276 Valve Check Ball									
<b>VALVE CONNECTION:</b>	N = NPT Connection									
<b>MOTOR SELECTION:</b>	1 = TEFC - NEMA 56C, 1P, 115/230V, 60Hz, 1/2 Hp 2 = TEFC - NEMA 56C, 3P, 230/460V, 50/60Hz, 1/2 Hp (VFD 10:1) 3 = Ex. Proof - NEMA 56C, 1P, 115/230V, 60Hz, 1/2 Hp 4 = Ex. Proof - NEMA 56C, 3P, 230/460V, 60Hz, 1/2 Hp 6 = TEFC - IEC 71, 3P, 220/380/460V, 50/60Hz, .37kW (VFD 10:1, Required for CE Approved VFD) X = No Motor - NEMA 56C Frame Ready Y = No Motor - IEC 71 Frame Ready									
<b>VFD OPTIONS</b>	A = No VFD C = VFD, 115/230V, NEMA 4X, IP65 Enclosure, 1 Phase, Motor 2 & 6 Only, Plus Motor Adder									
<b>OPTIONS</b>	XXX = No Options									

A completed model number should look like 'MD1BKTPN1A-XXX'

\*\* For use with high concentration of Sulfuric acid and poly-alum-chloride.

### Dimensions

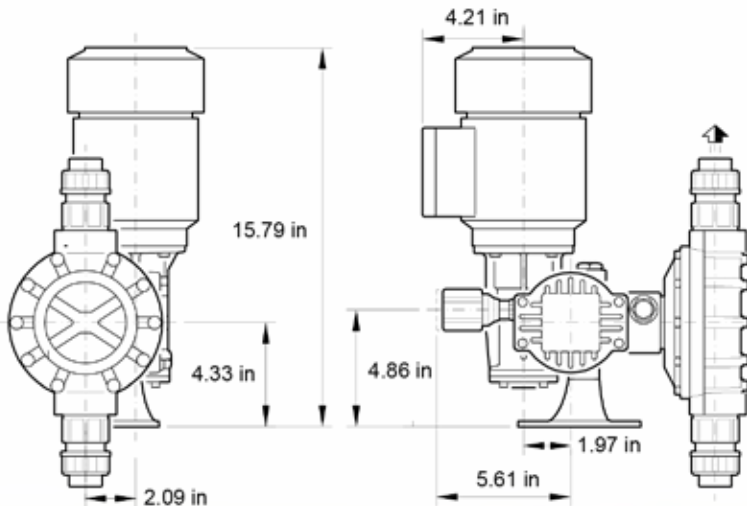

Series MD Dimensions (inches)		
Model	Weight Plastic (lbs)	Weight Stainless Steel (lbs)
MD1A (NO MOTOR)	21.5	26.0
MD1B (NO MOTOR)	21.5	26.0
MD1C (NO MOTOR)	21.5	26.0
MD1D (NO MOTOR)	21.5	26.0
MD1E (NO MOTOR)	21.5	26.0
MD2F (NO MOTOR)	26.0	37.0
MD2J (NO MOTOR)	26.0	37.0
MD2K (NO MOTOR)	26.0	37.0
MD3G (NO MOTOR)	29.0	46.0
MD1A W/VFD & MOTOR	67.0	71.5
MD1B W/VFD & MOTOR	67.0	71.5
MD1C W/VFD & MOTOR	67.0	71.5
MD1D W/VFD & MOTOR	67.0	71.5
MD1E W/VFD & MOTOR	67.0	71.5
MD2F W/VFD & MOTOR	71.5	82.5
MD2J W/VFD & MOTOR	72.5	83.5
MD2K W/VFD & MOTOR	73.5	84.5
MD3G W/VFD & MOTOR	74.5	91.5

# BLACK LINE

## Mechanical Diaphragm Pumps

Common Pump Accessories			
Component	Size	Material	Part No.
Drip Cover, Motor	56C	Steel, Baldor	NP999119-000
Pressure Relief Valves	1/2"	PVC/TFE	NA100001-PVC
	1/2"	PVDF/TFE	NA100001-PVD
	1/2"	SS/TFE	NA100001-316
	1"	PVC/TFE	NA100002-PVC
	1"	PVDF/TFE	NA100002-PVD
	1"	SS/TFE	NA100002-316
	1.5"	PVC/TFE	NA100003-PVC
	1.5"	PVDF/TFE	NA100003-PVD
Back Pressure Valves	1/2"	PVC/TFE	NA200001-PVC
	1/2"	PVDF/TFE	NA200001-PVD
	1/2"	SS/TFE	NA200001-316
	1"	PVC/TFE	NA200002-PVC
	1"	PVDF/TFE	NA200002-PVD
	1"	SS/TFE	NA200002-316
	1.5"	PVC/TFE	NA200003-PVC
	1.5"	PVDF/TFE	NA200003-PVD
Gauge Isolator w/ 200 PSI Gauge	1/4"	PVC/TFE	NA500001-PVC
	1/4"	PVDF/TFE	NA500001-PVD
	1/4"	316SS/TFE	NA500001-316
Calibration Column	1/2"	PVC 100mL	NA300001-PVC
	1/2"	PVC 200mL	NA300002-PVC
	3/4"	PVC 500mL	NA300003-PVC
	3/4"	PVC 1000mL	NA300004-PVC
	1"	PVC 2000mL	NA300005-PVC
	1"	PVC 4000mL	NA300006-PVC
	2"	PVC 10,000mL	NA300007-PVC
	2"	PVC 20,000mL	NA300008-PVC
	1/2"	Glass/PVD 100mL	NA300009-PVD
	1/2"	Glass/PVD 200mL	NA300010-PVD
	3/4"	Glass/PVD 500mL	NA300011-PVD
	3/4"	Glass/PVD 1000mL	NA300012-PVD
	1"	Glass/PVD 2000mL	NA300013-PVD
	1"	Glass/PVD 4000mL	NA300014-PVD
	1/2"	Glass/SS 100mL	NA300015-316
	1/2"	Glass/SS 200mL	NA300016-316
	3/4"	Glass/SS 500mL	NA300017-316
	3/4"	Glass/SS 1000mL	NA300018-316
	1"	Glass/SS 2000mL	NA300019-316
	1"	Glass/SS 4000mL	NA300020-316
Y Strainer	1/2"	PVC	40085
	1/2"	CPVC	NA400001-CPVC
	1/2"	PVD	NA400001-PVD
	1"	PVC	NA400002-PVC
	1"	CPVC	NA400002-CPVC
1"	PVD	NA400002-PVD	

150 PSI Pulsation Dampeners - Chargeable						
Volume	Body	Bladder	Connection	Part Number		
10 cubic inches	POLY	EPDM	3/8" FNPT	NA601038-FPPE		
		CSPE	3/8" FNPT	NA601038-FPPC		
		TFE	3/8" FNPT	NA601038-FPPT		
		Viton	3/8" FNPT	NA601038-FPPV		
		CSPE	1/2" FNPT	NA601050-FPPC		
		TFE	1/2" FNPT	NA601050-FPPT		
		Viton	1/2" FNPT	NA601050-FPPV		
		PVC	CSPE	1/2" FNPT	NA601050-PVCC	
			TFE	1/2" FNPT	NA601050-PVCT	
			Viton	1/2" FNPT	NA601050-PVCV	
			PVDF	EPDM	3/8" FNPT	NA601038-PVDE
				CSPE	3/8" FNPT	NA601038-PVDC
	TFE			3/8" FNPT	NA601038-PVDT	
	Viton	3/8" FNPT		NA601038-PVDV		
	316 SS	EPDM	3/8" FNPT	NA601038-316E		
		CSPE	3/8" FNPT	NA601038-316C		
		TFE	3/8" FNPT	NA601038-316T		
		Viton	3/8" FNPT	NA601038-316V		
		85 cubic inches	POLY	EPDM	3/4" FNPT	NA608575-FPPE
				CSPE	3/4" FNPT	NA608575-FPPC
	TFE			3/4" FNPT	NA608575-FPPT	
	Viton			3/4" FNPT	NA608575-FPPV	
	PVDF			EPDM	3/4" FNPT	NA608575-PVDE
				CSPE	3/4" FNPT	NA608575-PVDC
TFE			3/4" FNPT	NA608575-PVDT		
Viton			3/4" FNPT	NA608575-PVDV		
316 SS			EPDM	3/4" FNPT	NA608575-316E	
			CSPE	3/4" FNPT	NA608575-316C	
	TFE		3/4" FNPT	NA608575-316T		
	Viton		3/4" FNPT	NA608575-316V		
	370 cubic inches	POLY	EPDM	2" FNPT	NA637020-FPPE	
			CSPE	2" FNPT	NA637020-FPPC	
TFE			2" FNPT	NA637020-FPPT		
Viton			2" FNPT	NA637020-FPPV		
PVDF			EPDM	2" FNPT	NA637020-PVDE	
			CSPE	2" FNPT	NA637020-PVDC	
		TFE	2" FNPT	NA637020-PVDT		
		Viton	2" FNPT	NA637020-PVDV		
		316 SS	EPDM	2" FNPT	NA637020-316E	
			CSPE	2" FNPT	NA637020-316C	
TFE			2" FNPT	NA637020-316T		
Viton			2" FNPT	NA637020-316V		
36 cubic inches	POLY		EPDM	3/4" FNPT	NA603675-FPPE	
			CSPE	3/4" FNPT	NA603675-FPPC	
		TFE	3/4" FNPT	NA603675-FPPT		
		Viton	3/4" FNPT	NA603675-FPPV		
		PVDF	EPDM	3/4" FNPT	NA603675-PVDE	
			CSPE	3/4" FNPT	NA603675-PVDC	
	TFE		3/4" FNPT	NA603675-PVDT		
	Viton		3/4" FNPT	NA603675-PVDV		
	316 SS		EPDM	3/4" FNPT	NA603675-316E	
			CSPE	3/4" FNPT	NA603675-316C	
		TFE	3/4" FNPT	NA603675-316T		
		Viton	3/4" FNPT	NA603675-316V		
175 cubic inches		POLY	EPDM	2" FNPT	NA617520-FPPE	
			CSPE	2" FNPT	NA617520-FPPC	
	TFE		2" FNPT	NA617520-FPPT		
	Viton		2" FNPT	NA617520-FPPV		
	PVDF		EPDM	2" FNPT	NA617520-PVDE	
			CSPE	2" FNPT	NA617520-PVDC	
		TFE	2" FNPT	NA617520-PVDT		
		Viton	2" FNPT	NA617520-PVDV		
		316 SS	EPDM	2" FNPT	NA617520-316E	
			CSPE	2" FNPT	NA617520-316C	
	TFE		2" FNPT	NA617520-316T		
	Viton		2" FNPT	NA617520-316V		

Specifications: 150 PSI Maximum Pressure

# CHEM-TECH Peristaltic Pumps

## Series XP

The Chem-Tech XP Series with peristaltic technology delivers worry-free dosing in a modern design. Each and every component of the XP Series is designed and manufactured for optimum reliability and durability for REAL Performance.

The electronic timing circuit in the adjustable 'A' Models provides reliable pump control, without relying on mechanical adjustment components that wear out over time.

The intuitive interface and controls provide easy operation and the peristaltic design is virtually maintenance-free.

Tailor-made for the water conditioning market, the XP Series offer affordable solutions in both initial cost and operation. A rugged gear train and computer-aided peristaltic design ensure long-lasting performance.



Tested and Certified by WQA  
against NSF/ANSI 61 & CSA B483.1.



Chem-Tech Series XP & XPV Pumps.  
See [www.wqa.org](http://www.wqa.org) for  
certification parameters.

Intertek  
9700150

Intertek  
9700150

### Chem-Tech XP Series Selection Guide

MODELS:	Pump Size	Flow	Pressure Rating - PSI (Bar)				Tube Size	Speed (RPM)	XP ___	-	-	-	-
			Single Head Options			Duplex							
			'H' Tube	'L' Tube	'F' Tube	'L' Tube							
XP004	4 GPD (0.6 LPH)		125 (8.6)	80 (5.5)	60 (4.1) <sup>1</sup>	80 (5.5)	2	30					
XP007	7 GPD (1.1 LPH)							50					
XP009	9 GPD (1.4 LPH)		110 (7.6) <sup>1</sup>	70 (4.8)	50 (3.4) <sup>1</sup>	70 (4.8)	3	30					
XP015	15 GPD (2.4 LPH)							50					
XP014	14 GPD (2.3 LPH)		100 (5.9) <sup>1</sup>	50 (3.4)	40 (2.8) <sup>1</sup>	50 (3.4)	4	30					
XP023	23 GPD (3.6 LPH)							50					
XP030	30 GPD (4.7 LPH)		80 (5.5)	40 (2.8)		40 (2.8)	6	30					
XP050	50 GPD (7.9 LPH)							50					
XP048	48 GPD (7.5 LPH)					25 (1.7)	8	30					
XP080	80 GPD (12.6 LPH)							50					
ELECTRICAL:	L	115V, 60Hz											
	H	230V, 50/60Hz											
	R	230V, 50Hz with Grounded Right Angle European Plug											
Note: 50Hz pumps will produce 5/6 of the rated flow													
DRIVE:	F	Fixed Rate, On / Off Only											
	A	Adjustable 20:1 Turndown, On / Off with Current Interrupter Timer											
	G	Duplex Head - Fixed Rate, On / Off Only, 'L' Tube											
	B	Duplex Head - Adjustable, On / Off with Current Interrupter Timer, 'L' Tube											
	1	Pulse Input, .1 to 1 Second Timer											
	2	Pulse Input, .2 to 10 Second Timer											
	3	Pulse Input, 1 to 60 Second Timer											
	4	Dry Contact Input - Fixed Rate Pump											
	5	Dry Contact Input - Adjustable Pump											
6	Flow Switch Activated with 3/4" NPT Flow Switch - Fixed Rate Pump												
7	Flow Switch Activated with 3/4" NPT Flow Switch - Adjustable Rate Pump												
8	7 Day - 8 Event Electronic Timer - Fixed Rate Pump												
TUBING:	L	Low Pressure Norprene with 1/4" Tube Fittings											
	H	High Pressure Norprene with 1/4" Tube Fittings											
	3	Low Pressure Norprene with 3/8" Tube Fittings											
	4	High Pressure Norprene with 3/8" Tube Fittings											
	F	Fluran, Acid resistant tubing with 1/4" Tube Fittings (Doesnot include strainer & injector accessories)											
G	Fluran, Acid resistant tubing with 3/8" Tube Fittings (Doesnot include strainer & injector accessories)												
SYSTEM:	X	Pump Only											
	1	15 Gallon Tank System											
	3	35 Gallon Tank System											
	T	15 Gallon ITS System											

A completed model should look like "XP030LFLX"

# CHEM-TECH Peristaltic Pumps

## Series XPV

The Chem-Tech XPV Series pump combines the best in variable speed peristaltic pump technology with state of the art control electronics, providing you with unparalleled performance, control and value. The XPV represents the leading edge of microprocessor performance management, giving you many choices of input signal types, and onboard timer programs to customize this pump to any application. Of course, this pump is as rugged and reliable as it's fixed speed siblings, the XPF and the XPA

## Key Features

- Variable Speed
- Fully Scalable 4-20mA Input
- Hall Effect Input
- Contacting Head Water Meter
- Flow Totalization
- Cycle Timer
- Daily Timer
- LCD Display



Tested and Certified by WQA against NSF/ANSI 61 & CSA B483.1.



Chem-Tech Series XP & XPV Pumps. See [www.wqa.org](http://www.wqa.org) for certification parameters.



Intertek  
9700150



Intertek  
9700150

Chem-Tech Series XPV uses Chem-Tech Large Pump Discount Structure

### Chem-Tech XPV Series Selection Guide

MODELS:	Pump Size	Flow	Pressure Rating - PSI (Bar)				Tube Size	Speed (RPM)	XP ---	---	---	---	---
			Single Head Options			Duplex							
			'H' Tube	'L' Tube	'F' Tube	'L' Tube							
	XP008	8 GPD (1.3 LPH)	125 (8.6)	80 (5.5)	60 (4.1)	80 (5.5)	2	65 Max.					
	XP017	17 GPD (2.7 LPH)	110 (7.6)	70 (4.8)	50 (3.4) <sup>1</sup>	70 (4.8)	3						
	XP033	33 GPD (5.2 LPH)	100 (5.9)	50 (3.4)	40 (2.8) <sup>2</sup>	50 (3.4)	4	60 Max.					
	XP055	55 GPD (8.7 LPH)	80 (5.5)	40 (2.8)		40 (2.8)	6						
	XP100	100 GPD (15.8 LPH)		25 (1.7)		25 (1.7)	8						
ELECTRICAL:	L	115V, 60Hz											
	H	230V, 60/50Hz											
	R	230V, 60/50Hz with Grounded Right Angle European Plug											
DRIVE:	V	Variable Input Control with I/O Cable											
	G	Duplex Head - Low Pressure Norprene with 1/4" Tube Fitting											
TUBING:	L	Low Pressure Norprene with 1/4" Tube Fittings											
	H	High Pressure Norprene with 1/4" Tube Fittings											
	3	Low Pressure Norprene with 3/8" Tube Fittings											
	4	High Pressure Norprene with 3/8" Tube Fittings											
	F	Fluran, Acid resistant tubing with 1/4" Tube Fittings (Doesnot include strainer & injector accessories)											
	G	Fluran, Acid resistant tubing with 3/8" Tube Fittings (Doesnot include strainer & injector accessories)											
SYSTEM:	X	Pump Only											
	1	15 Gallon Tank System											
	3	35 Gallon Tank System											
	T	15 Gallon ITS System											

A completed model should look like "XP033LVXL"

<sup>1</sup>Max flow rate is 15 GPD (2.4 LPH) with Fluran tube.

<sup>2</sup>Max flow rate is 28 GPD (4.4 LPH) with Fluran tube.

<b>XP &amp; XPV Series Parts</b>	
<b>KOPkits - Low Pressure</b>	
Part Number	Description
NCKA2LPAP1	KOPkit XP - 004 / 007 / 008
NCKA3LPAP1	KOPkit XP - 009 / 015 / 017
NCKA4LPAP1	KOPkit XP - 023 / 033 / 014
NCKA6LPAP1	KOPkit XP - 030 / 050 / 055
NCKA8LPAP1	KOPkit XP - 048 / 080 / 100
<b>KOPkits - High Pressure</b>	
Part Number	Description
NCKA2HPAP1	KOPkit XP - 004 / 007 / 008
NCKA3HPAP1	KOPkit XP - 009 / 015 / 017
NCKA4HPAP1	KOPkit XP - 023 / 033 / 014
NCKA6HPAP1	KOPkit XP - 030 / 055
NCKA24PAP1	KOPkit XP - 004 / 007 / 008 - 3/8"
NCKA34PAP1	KOPkit XP - 009 / 015 / 017 - 3/8"
NCKA44PAP1	KOPkit XP - 033 / 014 / 023 - 3/8"
NCKA64PAP1	KOPkit XP - 030 / 055 - 3/8"
<b>KOPkits - Low Pressure 3/8"</b>	
Part Number	Description
NCKA43PAP1	KOPkit XP - 023 / 033 / 014
NCKA63PAP1	KOPkit XP - 030 / 050 / 055
<b>KOPkits - Duplex Low Pressure</b>	
Part Number	Description
NCKD2LPAP1	KOPkit XP - 004 / 008
NCKD3LPAP1	KOPkit XP - 009 / 017
NCKD4LPAP1	KOPkit XP - 033 / 014
NCKD6LPAP1	KOPkit XP - 030 / 055
NCKD8LPAP1	KOPkit XP - 048 / 100
<b>KOPkits - Duplex High Pressure</b>	
Part Number	Description
NCKD2LPAP1	KOPkit XP - 004 / 008
NCKD3HPAP1	KOPkit XP - 009 / 017
NCKD4HPAP1	KOPkit XP - 033 / 014
NCKD6HPAP1	KOPkit XP - 030 / 055

<b>TUBE KITS</b>	
<b>Low Pressure 1/4" Tube Fittings</b>	
Part Number	Description
NC90XX2LPA-XXXXX	Kit, Tube Assy - 004 / 007 / 008
NC90XX3LPA-XXXXX	Kit, Tube Assy - 009 / 015 / 017
NC90XX4LPA-XXXXX	Kit, Tube Assy - 023 / 033 / 014
NC90XX6LPA-XXXXX	Kit, Tube Assy - 030 / 050 / 055
NC90XX8LPA-XXXXX	Kit, Tube Assy - 048 / 080 / 100
<b>High Pressure 1/4" Tube Fittings</b>	
Part Number	Description
NC90XX2HPA-XXXXX	Kit, Tube Assy - 004 / 007 / 008
NC90XX3HPA-XXXXX	Kit, Tube Assy - 009 / 015 / 017
NC90XX4HPA-XXXXX	Kit, Tube Assy - 023 / 033 / 014
NC90XX6HPA-XXXXX	Kit, Tube Assy - 030 / 055
<b>Low Pressure 3/8" Tube Fittings</b>	
Part Number	Description
NC90XX23PA-XXXXX	Kit, Tube Assy - 004 / 007 / 008
NC90XX33PA-XXXXX	Kit, Tube Assy - 009 / 015 / 017
NC90XX43PA-XXXXX	Kit, Tube Assy - 023 / 033 / 014
NC90XX63PA-XXXXX	Kit, Tube Assy - 030 / 050 / 055
NC90XX83PA-XXXXX	Kit, Tube Assy - 048 / 080 / 100
<b>High Pressure 3/8" Tube Fittings</b>	
Part Number	Description
NC90XX24PA-XXXXX	Kit, Tube Assy - 004 / 007 / 008
NC90XX34PA-XXXXX	Kit, Tube Assy - 009 / 015 / 017
NC90XX44PA-XXXXX	Kit, Tube Assy - 023 / 033 / 014
NC90XX64PA-XXXXX	Kit, Tube Assy - 030 / 055
<b>Fluran 1/4" Tubing Fittings</b>	
Part Number	Description
NC90XX2FPA-XXXXX	Kit, Tube Assy - 004 / 007 / 008
NC90XX3FPA-XXXXX	Kit, Tube Assy - 009 / 015 / 017
NC90XX4FPA-XXXXX	Kit, Tube Assy - 023 / 033 / 014
<b>Fluran 3/8" Tubing Fittings</b>	
Part Number	Description
NC90XX2GPA-XXXXX	Kit, Tube Assy - 004 / 007 / 008
NC90XX3GPA-XXXXX	Kit, Tube Assy - 009 / 015 / 017
NC90XX4GPA-XXXXX	Kit, Tube Assy - 023 / 033 / 014

<b>XPV Series Parts</b>	
Part Number	Description
J63006	Drive Motor, Variable Speed
J63115	Fuse Kit, Variable Speed

<b>Parts</b>	
Part Number	Description
J63051	Access. Kit, PVC/VTN, .25N
J30257	Grease Kit
J60609	Strainer Assembly w/o Valve
J63002	Control Panel Cover (Clear)
J63004	Rain Hood
J63007	Switch, On-Off

Part Number	Description
J63016	Gear Motor, 30RPM / 120V / 50-60Hz
J63017	Gear Motor, 30RPM / 240V / 50-60Hz
J63018	Gear Motor, 50RPM / 120V / 50-60Hz
J63019	Gear Motor, 50RPM / 240V / 50-60Hz
J63023	Housing Assy, 100% Fixed Rate
U8800712	Injection Valve Assembly
NC82XX3LP1-XXXXX	Roller Assy For Size 2-6 Tubes
NC82XX8LP1-XXXXX	Roller Assy For Size 8 Tube

# CHEM-TECH Mechanical Diaphragm Pumps

## Series Prime Performance

The Chem-Tech Prime Performance Series pumps have a specially designed degassing valve system for applications using off-gassing chemicals like sodium hypochlorite. Built upon motorized-diaphragm technology, the Prime Performance Series delivers dependable performance, extended longevity and consistent metering over long periods of time in a compact form.

A top-mounted, one-way vent valve assembly evacuates gas bubbles from the pump head, providing for reliable operation.



Standard Agency Listings		
Model	ETL	ETLsan
All 60Hz	X	X
All 50Hz		

Contact factory for alternate listings

Contact factory for applicable agency approvals.



PRIME PERFORMANCE Selection Guide		X	---	---	A	---	---
<b>MODELS:</b>	<b>015</b> = 15 gpd (2.34 lph) max pres.: 100 PSI (7 BAR) <b>024</b> = 24 gpd (3.78 lph) max pres.: 100 PSI (7 BAR) <b>030</b> = 30 gpd (4.72 lph) max pres.: 100 PSI (7 BAR) <b>068</b> = 68 gpd (10.72 lph) max pres.: 60 PSI (4 BAR) <b>100</b> = 100 gpd (15.76 lph) max pres.: 60 PSI (4 BAR)						
<b>ELECTRICAL:</b>	<b>XA</b> = 115V, 60 Hz <b>XB</b> = 230V, 50 Hz <b>XC</b> = 230V, 60 Hz						
<b>LIQUID END MATERIALS:</b> Head, Fittings/ Diaph., Seats/ Balls	<b>BAA</b> = PVC / CSPE / Ceramic <b>BBA</b> = PVC / Viton / Ceramic						
<b>CONNECTION SIZES:</b>	<b>6</b> = Tubing .38" PE BLK Suction / .38" PE BLK Discharge / .38" PE BLK Return <b>8</b> = Tubing .38" PVC Suction / .38" PE Discharge / .38" PVC Return <b>7</b> = Tubing .50" PE BLK Suction / .50" PE BLK Discharge / .50" PE BLK Return <b>9</b> = Tubing .44" PVC Suction / .50" PE Discharge / .44" PVC Return						
<b>SUFFIX CODES:</b>	<b>XXX</b> = Standard <b>001</b> = Current Interrupter <b>15T</b> = 15 gal tank w/ bulkhead for vent, level wand, safety cap & fasteners <b>35T</b> = 35 gal tank w/ bulkhead for vent and fasteners						

**A complete model should look like "X024-XA-BBA9XXX"**

Pumps come with foot valve/strainer/weight, 4' of suction tubing, 4' of return tubing, 8' of discharge tubing, and injection/back pressure valve assembly.

# CHEM-TECH KOPkits

PRIME PERFORMANCE KOPkit Selection Guide		KX100	---	A	---
<b>PRODUCT DESIGNATOR:</b>	<b>KX100</b> = Chem-Tech Kopkit				
<b>LIQUID END MATERIALS:</b> Head, Diaph., Seats & Balls	<b>BAA</b> = PVC / CSPE / Ceramic <b>BBA</b> = PVC / Viton / Ceramic				
<b>CONNECTION :</b>	<b>6</b> = Tubing .38" Suction / Discharge / Return <b>8</b> = Tubing .38" Suction / Discharge / Return <b>7</b> = Tubing .50" Suction / Discharge / Return <b>9</b> = Tubing .44" Suction & Return / .50" Discharge				



# CHEM-TECH Mechanical Diaphragm Pumps

## Series 100, 150

Series 100 Models - The preferred metering pump for water conditioning professionals around the world. Perfect for applications where economical, consistent performance is required. Capable of a wide range of flows, from less than 3 USgpd up to 30 USgpd and pressures up to 100 psig.

Series 150 Models - Built upon the same solid platform as the 100 Models, these units are capable of higher flowrates. With a range offering up to 100 USgpd, the Series 150 can meet the demands of larger applications. Maximum pressure is 60 psig.

**Note: Standard Features do not add to the pump price.**



Standard Agency Listings		
Model	ETL	ETLsan
All 60Hz	X	X
100-150 50Hz		
Contact factory for alternate listings		

Contact factory  
for applicable  
agency  
approvals.



### Chem-Tech Series 100, 150 Selection Guide

MODELS:	Series 100	
	X003	= 3 gpd (0.47 lph) max pres.: 100 PSI (7 BAR)
	X007	= 7 gpd (1.00 lph) max pres.: 100 PSI (7 BAR)
	X015	= 15 gpd (2.34 lph) max pres.: 100 PSI (7 BAR)
	X024	= 24 gpd (3.78 lph) max pres.: 100 PSI (7 BAR)
	X030	= 30 gpd (4.72 lph) max pres.: 100 PSI (7 BAR)
	Series 150	
	X068	= 68 gpd (10.72 lph) max pres.: 60 PSI (4 BAR)
	X100	= 100 gpd (15.76 lph) max pres.: 60 PSI (4 BAR)

ELECTRICAL:	XA	= 115V, 60 Hz
	XC	= 230V, 60 Hz

LIQUID END MATERIALS:	AAA	= Clear PVC / CSPE / Ceramic
Pump Head & Fittings/Seats & O-rings/Balls	AAB	= Clear PVC / CSPE / TFE
	ABA	= Clear PVC / Viton / Ceramic
	ABB	= Clear PVC / Viton / TFE
	ACA	= Clear PVC / TFE/Viton / Ceramic
	AHA	= Clear PVC / TFE/CSPE / Ceramic
	DAA	= PP / CSPE / Ceramic
	DAB	= PP / CSPE / TFE
	DBA	= PP / Viton / Ceramic
	DBB	= PP / Viton / TFE
	GFA	= Clear PVC / TFE / Ceramic (dbl)
	GFB	= Clear PVC / TFE / TFE (dbl)
	EFC	= 316SS / TFE / 316SS (dbl)

CONNECTION SIZES:	A	= Tubing .44" PVC Suction / .50" PE Discharge
	C	= Tubing .38" PVC Suction / .38" PE Discharge
	F	= Tubing .44" PVC Suction / .50" PE BLK Discharge
	S	= Tubing .38" PVC Suction / .38" PE BLK Discharge
	X w/ 316	= .25" FNPT Suction / .25" FNPT Discharge

SUFFIX CODES:	XXX	= Standard
	001	= Current Interrupter
	500*	= Five Function Valve
	520*	= Five Function Degas Valve
	ITS	= 15 gal ITS Tank System

\* Not available in SS. Adder price is per head.

A completed model number should look like "X015-XA-BAAAXX"



### Chem-Tech KOPkit Selection Guide

PRODUCT DESIGNATOR: **KX100** = Chem-Tech Kopkit KX100 - - - - -

**LIQUID END MATERIALS:**  
Head, Diaph., Seats & Balls

<b>AAA</b>	= Clear PVC / CSPE / Ceramic
<b>AAB</b>	= Clear PVC / CSPE / TFE
<b>ABA</b>	= Clear PVC / Viton / Ceramic
<b>ABB</b>	= Clear PVC / Viton / TFE
<b>ACA</b>	= Clear PVC / TFE/Viton / Ceramic
<b>AHA</b>	= Clear PVC / TFE/CSPE / Ceramic
<b>BAA</b>	= PVC / CSPE / Ceramic
<b>BAB</b>	= PVC / CSPE / TFE
<b>BBA</b>	= PVC / Viton / Ceramic
<b>BBB</b>	= PVC / Viton / TFE
<b>BHA</b>	= PVC / TFE/CSPE / Ceramic
<b>DAA</b>	= PP / CSPE / Ceramic
<b>DAB</b>	= PP / CSPE / TFE
<b>DBA</b>	= PP / Viton / Ceramic
<b>DBB</b>	= PP / Viton / TFE
<b>GFA</b>	= Clear PVC / TFE / Ceramic (dbl)
<b>GFB</b>	= Clear PVC / TFE / TFE (dbl)
<b>EFC</b>	= 316SS / TFE / 316SS (dbl)

**CONNECTION :**

<b>A</b>	= Tubing .44" PVC Suction / .50" PE Discharge
<b>C</b>	= Tubing .38" PVC Suction / .38" PE Discharge
<b>F</b>	= Tubing .44" PVC Suction / .50" PE BLK Discharge
<b>S</b>	= Tubing .38" PVC Suction / .38" PE BLK Discharge
<b>X w/ 316</b>	= .25" FNPT Suction / .25" FNPT Discharge

Series 100 KOPkits	
Part Number	Description
KX100-AAAA	KOPKIT, STD S100/150/200
KX100-AAAC	KOPKIT, STD S100/150/200
KX100-AAAE	KOPKIT, STD S100/150/200
KX100-AAAF	KOPKIT, STD S100/150/200
KX100-AAAS	KOPKIT, STD S100/150/200
KX100-AABA	KOPKIT, STD S100/150/200
KX100-AABC	KOPKIT, STD S100/150/200
KX100-AABF	KOPKIT, STD S100/150/200
KX100-ABAA	KOPKIT, STD S100/150/200
KX100-ABAC	KOPKIT, STD S100/150/200
KX100-ABAF	KOPKIT, STD S100/150/200
KX100-ABAS	KOPKIT, STD S100/150/200
KX100-ABBA	KOPKIT, STD S100/150/200
KX100-ABBC	KOPKIT, STD S100/150/200
KX100-ACAA	KOPKIT, STD S100/150/200
KX100-ACAC	KOPKIT, STD S100/150/200
KX100-AHAA	KOPKIT, STD S100/150/200
KX100-BAA6	KOPKIT, S100 DEGAS
KX100-BAA7	KOPKIT, S100 DEGAS
KX100-BAA8	KOPKIT, S100 DEGAS
KX100-BAA9	KOPKIT, S100 DEGAS
KX100-BAAA	KOPKIT, STD S100/150/200
KX100-BAAC	KOPKIT, STD S100/150/200
KX100-BABA	KOPKIT, STD S100/150/200
KX100-BABC	KOPKIT, S100/150/200
KX100-BABF	KOPKIT, STD S100/150/200
KX100-BBA6	KOPKIT, S100 DEGAS
KX100-BBA7	KOPKIT, S100 DEGAS
KX100-BBA8	KOPKIT, S100 DEGAS
KX100-BBA9	KOPKIT, S100 DEGAS
KX100-BBAA	KOPKIT, STD S100/150/200
KX100-BBAC	KOPKIT, STD S100/150/200
KX100-BBBC	KOPKIT, STD S100/150/200
KX100-BCAA	KOPKIT, STD S100/150/200
KX100-BCAC	KOPKIT, STD S100/150/200
KX100-BCBA	KOPKIT, STD S100/150/200
KX100-BHAA	KOPKIT, STD S100/150/200
KX100-BHAC	KOPKIT, STD S100/150/200
KX100-DAAA	KOPKIT, STD S100/150/200
KX100-DBAA	KOPKIT, STD S100/150/200
KX100-DBBA	KOPKIT, STD S100/150/200
KX100-DCAA	KOPKIT, STD S100/150/200
KX100-EFCX	KOPKIT, STD S100/150/200
KX100-GFAA	KOPKIT, STD S100/150/200
KX100-GFAC	KOPKIT, STD S100/150/200
KX100-GFAQ	KOPKIT, STD S100/150/200
KX100-GFBA	KOPKIT, STD S100/150/200

Series 100, 150, 100D, 150D And 200 Parts	
Part Number	Description
00006	Suction Tubing - 7/16" OD - Per ft Min 25 Ft
00007	Suction Tubing - 3/8" - Per ft Min 25 Ft
00008	Discharge Tubing - 1/2" OD - Per ft Min 25 Ft
00009	Discharge Tubing - 1/2" Black - Per ft Min 25 Ft
00010	Discharge Tubing - 3/8" - Per ft Min 25 Ft
00011	Discharge Tubing - 3/8" Black - Per ft Min 25 Ft
J30507	Kit, Bleed, Valve, PVC/HPY/ 3/8
J30509	Kit, Bleed, Valve, PVC/VTN/ 3/8
J30510	Kit, Bleed, Valve, PVC/TFE/ 3/8
J30511	Kit, Bleed, Valve, FPP/CSPE/ 3/8
J30513	Kit, Bleed, Valve, FPP/VTN/ 3/8
J30514	Kit, Bleed, Valve, FPP/TFE/ 3/8
J30515	Kit, Bleed, Valve, PVC/HPY/ 1/2
J30517	Kit, Bleed, Valve, PVC/VTN/ 1/2
J30518	Kit, Bleed, Valve, PVC/TFE/ 1/2
J30519	Kit, Bleed, Valve, FPP/CSPE/ 1/2
L3300V03-FPP	Kit, Bleed, Valve, FPP/VTN/ 1/2
J30522	Kit, Bleed, Valve, FPP/TFE/ 1/2
J60717	Foot Valve & Strainer Assy (PVD-CSPE-C-3/8")
J60729	Foot Valve & Strainer Assy (PVD-CSPE-C-1/2")
J60718	Foot Valve & Strainer Assy (PVD-VT-C-3/8")
J60730	Foot Valve & Strainer Assy (PVD-VT-C-1/2")
41657	Injection Valve Assy (PVC-CSPE-C-3/8")
J41658	Injection Valve Assy (PVC-CSPE-C-1/2")
41659	Injection Valve Assy (PP-VT-C-1/2")
41661	Injection Valve Assy (PVC-VT-C-1/2")
J41694	Injection Valve Assy (PVC-CSPE-C-1/2")
41695	Injection Valve Assy (PVC-VT-C-3/8")
41696	Injection Valve Assy (PP-VT-C-3/8")
41705	6" Ck Vlv Inj Assy (PVC-CSPE-C-3/8")
41707	6" Ck Vlv Inj Assy (PVC-VT-C-3/8")
41708	6" Ck Vlv Inj Assy (PVC-VT-C-1/2")
41710	6" Ck Vlv Inj Assy (PP-VT-C-1/2")
41795	Injection Valve Assy (PVC-CSPE-C-1/2" x 1/2" NPT)
J61222	Kit, 5 Function Valve incl L380DT03-PVD for Series 100/200
J61539	Kit, 5 Function Valve incl L380DT02-PVD for Series 100/200
J30503	Motor - 115V, 60 Hz, S200
J30504	Motor - 230V, 50 Hz, S200
J30505	Motor - 230V, 60 Hz, S200
32520	Motor - 7 SPM, 115V, 60 Hz, 003
32521	Motor - 13 SPM, 115V, 60 Hz, 007
32522	Motor - 25 SPM, 115V, 60 Hz, 015
32523	Motor - 51 SPM, 115V, 60 Hz, 024/030/068
32524	Motor - 7 SPM, 230V, 60 Hz, 003
32527	Motor - 51 SPM, 230V, 60 Hz, 024/030/068
32528	Motor - 7 SPM, 230V, 50 Hz, 003
32530	Motor - 25 SPM, 230V, 50 Hz, 015
32531	Motor - 51 SPM, 230V, 50 Hz, 024/030/068
32532	Motor - 70 SPM, 115V, 60 Hz, 100
32533	Motor - 70 SPM, 230V, 50 Hz, 100
32535	Motor - 70 SPM, 230V, 60 Hz, 100

**CHEM-TECH** Mechanical Diaphragm Pumps

Series 250 Parts	
Part Number	Description
00006	Suction Tubing 7/16" OD <span style="float: right;">Per Ft Min 25 Feet</span>
J00012	Polypropylene Tubing, 1/2" OD - Discharge <span style="float: right;">Per Ft Min 25 Feet</span>
00013	Polypropylene Tubing, 1/2" OD-Discharge - Black <span style="float: right;">Per Ft Min 25 Feet</span>
J24960	Coupling Nut - PVC 1/2"
25681	Diaphragm Assembly - Model 253
25682	Diaphragm Assembly - Model 254
J27903	Gasket, TFE
J28919	Head Assembly, PVC - Model 253 - 1/2"
28920	Head Assembly, PVC - Model 254 - 1/2"
32545	Motor, 115/230V, 50/60 Hz, TEFC
34532	Oil Filler Plug with Cap
37886	Diaphragm Shaft
J41658	Injection Valve Assy (PVC-CSPE-C-1/2")
J41667	Double Ball Check Valve Cart Assy (PVC 1/2") Suc.
41668	Double Ball Check Valve Cart Assy (PVC 3/8") Disch
J41669	Double Ball Check Valve Cart Assy (PVC 1/2") Disch
J60729	Foot Valve & Strainer Assy (PVD-CSPE-C-1/2")
J61516	Kit, Head Mounting Bolts (4 - J37005, 4 - J42020)
J61518	Kit, Gasket TFE (4 - J27930)

# MEC-O-MATIC Peristaltic Pumps

## Series Dolphin

- Exclusive quick-release, twist-off, clear polycarbonate, acid-resistant head to withstand the harshest environment.
- Self-lubricating chemical resistant roller assembly.
- Durable, long lasting tubing with no tube adjustment.
- Rugged and dependable – Heavy-duty shaded pole gearmotor with lifetime lubrication.
- Flexibility in feed rates - from .13 gallons to 97 gallons per day ... to meet the demands of the pool and spa Industry, and elsewhere.
- Agency approvals.



Tested and Certified by WQA  
against NSF/ANSI 61 & CSA B483.1.



Chem-Tech Series XP & XPV Pumps.  
See www.wqa.org for  
certification parameters.



Intertek  
9700150



Intertek  
9700150

Contact factory  
for applicable  
agency  
approvals.

### Mec-O-Matic DOLPHIN Series Selection Guide

<b>MODELS:</b>	10 = 13.0 gpd (2.05 lph) max pres.: 25 PSI (1.72 BAR)	UD__	-	__	-	__	-	U	XXX
	50 = 60.0 gpd (9.46 lph) max pres.: 25 PSI (1.72 BAR)								
	75 = 97.0 gpd (15.30lph) max pres.: 25 PSI (1.72 BAR)								
<b>ELECTRICAL:</b>	XA = 115V, 60 Hz								
	XL = Standard 230V, 50/60 Hz, used w/ Model 10 only								
	XB = Standard 230V, 50 Hz, used w/ Models 50 & 75 only								
	XC = Standard 230V, 60 Hz, used w/ Models 50 & 75 only								
<b>LIQUID END MATERIALS:</b>	LSA = Norprene Tubing								
	LBA = Viton Tubing								
<b>CONNECTION SIZES:</b>	U = Tubing .25" I.D. X .44" O.D.								
<b>SUFFIX CODES:</b>	XXX = Standard								

A completed model should look like "UD75-XA-LBAUXXX"

Junction Box option is available on 230V models at no additional charge. Contact the factory for model numbers. Shipping weight for Dolphin Pumps is 7 lbs.

### Mec-O-Matic DOLPHIN KOPkit Selection Guide

<b>PRODUCT DESIGNATOR:</b>	KUDXX = Dolphin Kopkit	KUDXX	-	_____
<b>LIQUID END MATERIALS:</b>	LSAU = Norprene Tubing CRM			
	LLAU = Norprene Tubing BLK			
	LBAU = Viton Tubing			

### DOLPHIN Series KOPkits

Part Number	Description
KUDXX-LBAU	KOPKIT, STD UD10/50/75 LBAU
KUDXX-LLAU	KOPKIT, STD UD10/50/75 LLAU
KUDXX-LSAU	KOPKIT, STD UD10/50/75 LSAU

### DOLPHIN Series Parts

Part Number	Description
J60552	Strainer Assembly w/o valve
U0818616	Gearmotor Assembly, 120V, 10 RPM - D10
U0818617	Gearmotor Assembly, 240V, 10 RPM - D10
U0818618	Gearmotor Assembly, 120V, 50 RPM - D50
U0818619	Gearmotor Assembly, 240V, 50 RPM - D50
U0818620	Gearmotor Assembly, 120V, 75 RPM - D75
U0818621	Gearmotor Assembly, 240V, 75 RPM - D75
U8800431	Tubing cut 1/4" X 15 ft. PE
U8800637	Tubing Replacement Kit (7/16"Norprene Crm)
U8800712	Injection Fitting
U8800740	Kit, Timer 120V (1 - U0818183, 1 - U0020522)
U8800741	Kit, Timer 240V (1 - U0818182, 1 - U0020522)
U8800743	Kit, Collars (2 - U0817123)
U8800758	Kit, Pump Head Tubing (Viton)

# MEC-O-MATIC Peristaltic Pumps

## Series VSP

- Versatile - The VSP is engineered to dispense low volumes of chemicals at exacting amounts.
- Reliable – Heavy-duty gearmotor... fieldtested, proven peristaltic head... durable chemical-resistant housing.
- Low Maintenance – Self-lubricating roller assembly... NO tube adjustment required... exclusive quick-release, twist-off head.
- Guaranteed – Full one year warranty on dispenser.



### Mec-O-Matic VSP Series Selection Guide

<b>MODELS:</b>	12 = 12.0 gpd (1.89 lph) max pres.: 25 PSI (1.72 BAR)	UVSP	--	---	U	XXX
	20 = 20.0 gpd (3.15 lph) max pres.: 25 PSI (1.72 BAR)					
<b>ELECTRICAL:</b>	XP = 24VAC					
	XR = 120V 50/60 Hz					
<b>LIQUID END MATERIALS:</b>	LLA = Norprene Tubing					
	LBA = Viton Tubing					
<b>CONNECTION SIZES:</b>	U = Tubing .19" I.D. X .38" O.D. used w/ UVSP12 only					
	U = Tubing .25" I.D. X .44" O.D. used w/ UVSP20 only					
<b>SUFFIX CODES:</b>	XXX = Standard					

A completed model should look like "UVSP12XRLLAUXXX"

Shipping weight for all VSP pumps is 6 lbs.

### VSP Series KOPkits

Part Number	Description
KUD12-LLAU	KOPKIT, STD VSP12 LLAU

### VSP Series Parts

Part Number	Description
J60552	Strainer w/o Valve
U0817122	Collar VSP - 12
U0817123	Collar VSP - 20
U0817742	Hose Clamps
U0818305	Printed Circuit Board 24V
U0818306	Printed Circuit Board 120V
U0818463	Fuse 24V, 1/2 Amp
U0818464	Fuse 120V, 1/8 Amp
U0818667	Gearmotor Kit
U7013397	Tube Kit VSP - 20
U8800431	15" X 1/4" Poly Tubing
U8800651	Pump Head Kit
U8800700	Tube Kit VSP - 12
U8800712	IPF Auto Clean Injection Fitting
U8800739	Kit, Motor Mount (2 - U0818666, 2 - 32946, 2 - U0811297)

# MEC-O-MATIC Peristaltic Pumps

## Series 2400T Grease Trap Dispenser

- Capable of Dispensing Low Volumes
- Programmable
- Simple Installation
- Prime Push Button for Quick Start-Up
- Quick Release Twist Off Head
- Built-In Timer
- No Tube Adjustment Needed
- Self Lubricating Roller Assembly



Contact factory for applicable agency approvals.

### Mec-O-Matic 2400T Series Selection Guide

<b>MODELS:</b>	UT24 = 2.5 gpd (0.39 lph) max pres.: 25 PSI (1.72 BAR) used w/ 2400T & 2400T PLUS	UT24	---	---	---	---
<b>ELECTRICAL:</b>	-XA = 115V, 60 Hz used w/ 2400T only PXA = 115V, 60 Hz used w/ 2400T PLUS only					
<b>LIQUID END MATERIALS:</b>	LT = Silicone Tubing LB = Viton Tubing					
<b>CONNECTION</b>	AU = Tubing .125" I.D. X .31" O.D.					
<b>SUFFIX CODES:</b>	XXX = Standard					

A completed model should look like "UT24-XA-LBAUXXX"

- 2400T comes standard with 24 hour mechanical timer. 2400T plus utilizes a 7 day, 8 event programmable timer
- Shipping weight is 7.5 lbs.

### 2400T & T PLUS Series Parts

Part Number	Description
J60552	Strainer Assembly w/o Valve
U0817131	Tubing Assy 5/16" X 9" Silicone
U0817742	Hose Clamp
U0817942	Screw 10 - 30 X .688", Motor Mount
U0817952	Timer (2400T)
U0818602	Gearmotor Assembly
L9710800-000	Timer (2400T Plus)
U8800431	15' X 1/4" PE Tubing
U8800712	Injection Fitting
U8800753	Pump Head Assembly Kit (No Tubing)

### 2400T DC Series Parts

Part Number	Description
U0818881	12V DC Motor
U0818895	1/4" X 20' Tubing PE
U8800490	Injection Fitting
U8800637	7/16" Tubing Kit (Peristaltic)
U8800651	Pump Head Assembly Kit (No Tubing)
U8800700	3/8" Tubing Kit
U8800742	Kit, Pump Head Bearings (2 - U0817121)

## Policies and Procedures

### 1. Manufacturer's Equipment Warranty

- a. Pulsafeeder warrants all pumps and controllers of its manufacture to be free of defects in material or workmanship. Liability under this policy extends for 24 months from the date of shipment. The manufacturer's liability is limited to repair or replacement of any failed equipment or part which is proven defective in material or workmanship upon manufacturer's examination. This warranty does not include removal or installation costs and in no event shall the manufacturer's liability exceed the selling price of such equipment or part.
- b. The manufacturer disclaims all liability for damage to its products through improper installation, maintenance, use or attempts to operate such products beyond their functional capacity, intentionally or otherwise, or any other unauthorized repair. The manufacturer is not responsible for consequential or other damages, injuries or expense incurred through the use of its products.
- c. The above warranty is in lieu of any other warranty, whether expressed or implied. The manufacturer makes no warranty of fitness or merchantability. No agent of ours is authorized to provide any warranty other than the above.
- d. MicroVision EX when purchased as a spare a part is warranted for 24 months.

### 2. Pulsafeeder's Parts and Accessory Warranty

- a. Pulsafeeder, Inc. warrants parts and accessories provided to be free of defects in material or workmanship. Unless otherwise noted below, liability under this policy extends for 90 days from date of shipment from the factory when sold as service parts. (Replaceable elastomeric parts (PTFE) are expendable and are not covered by any warranty either expressed or implied.)
- b. This policy is extended to a full 12 months from the date of installation or 18 months from shipment from the factory whichever comes first on the following accessories;
 

Digital Glycol Feeders	Pre-Engineered Systems	Corrosion Coupon Racks
Analog Timers	Water Meters	Flow Controllers
- c. Toroidal probes are warranted for 24 months from date of shipment from the factory when purchased as a spare.. All other electrodes/probes and sensors are considered maintenance items and such are warranted for six (6) months from the date of shipment when purchased in conjunction with the controller. Any electrodes/probes other than toroidal and sensors purchased as spare parts are warranted for 90 days from date of shipment.
- d. The manufacturer's liability is limited to repair or replacement of any failed equipment or part which is proven defective in material or workmanship upon manufacturer's examination. This warranty does not include removal or installation costs and in no event shall the manufacturer's liability exceed the selling price of such equipment or part.
- e. The manufacturer disclaims all liability for damages to its products through improper installation, maintenance, use or attempts to operate such products beyond their functional capacity, intentionally or otherwise, or any unauthorized repair. The manufacturer is not responsible for consequential or other damages, injuries or expense incurred through the use of its products.
- f. The above warranty is in lieu of any other warranty, whether expressed or implied. The manufacturer makes no warranty of fitness or merchantability. No agent of ours is authorized to provide any warranty other than the above.

### 3. Process for All Returned Goods (Warranty Items)

- a. Please contact our Technical Service Department to request a RMA (Return Material Authorization) number prior to returning any goods. The following information will be required:
  - Billing and ship-to address
  - Model number and serial number
  - Contact name and phone number
  - Reason for return
  - Purchase order (where applicable)
  - A packing slip will be provided to the shipper and MUST accompany the product being returned. Packages received without our proper packing list will be refused by the receiver.
- b. All material must be returned freight prepaid.
- c. All material must be properly packaged to prevent damage in shipment.
- d. All products used in a chemical application MUST accompany an MSDS
- e. All products MUST be wiped and flushed clean of any and all chemicals, solvents or buffers and be warranted to be safe for handling. You will be requested to acknowledge the condition of the product being returned on our packing list. Any product received that is deemed to be unsafe for handling or without this acknowledgment will be refused by our receiver.
- f. All warranty repairs will follow the 2 year warranty policy and will refer to the original purchase date.



#### 4. Credit for Return of New, Unused Equipment

- a. RMA for returning product for credit is effective for 90 days from the date of issue. After 90 days if the product has not been returned to Pulsafeeder the RMA number will be canceled, and a new request must be made by the customer to continue with the return procedure.
- b. No equipment will be accepted beyond six months after date of shipment from factory for credit.
- c. Only new, unused and undamaged standard equipment will be accepted for return to stock.
- d. All credits are based on evaluation and acceptance of material as new and unused by Pulsafeeder. You will be requested to acknowledge the condition of the product being returned on our packing list. Any product received that is deemed to be unsafe for handling or without this acknowledgment will be refused by our receiver.
- e. A restocking fee of 25% will apply to returned goods. When a PO is provided for a replacement item at the time of the return request the restocking fee will be 15%. Note: any product mounted on a panel or skid will be charged a 50% re-stocking fee.
- f. A request for a Returned Material Authorization (RMA) number must be made prior to returning product to Pulsafeeder.
- g. All equipment shall be returned with the RMA Packing List form attached to the outside of the box.
- h. If any chemical, solvent or buffer has been introduced into the product it must be wiped and flushed clean of any and all substances prior to returning to Pulsafeeder.
- i. All material shall be returned freight prepaid.
- j. Private label products or Engineered Panel Mount Systems and Pre-Engineered System are not returnable.

#### 5. Pricing Errors

- a. Pulsafeeder does their very best to avoid errors in billing. You will receive a confirmation of your order within 24 hours of order entry. If upon review the customer feels there is a discrepancy, they should contact Pulsafeeder Customer Service as soon as possible to resolve.
- b. Should an invoice be received that the customer believes to have incorrect pricing, they should notify Pulsafeeder Customer Service to investigate.

#### 6. Missing Items

- a. If a product is received by the customer with an item missing the customer must notify Pulsafeeder Customer Service within 7 days of receipt of the product by the end user. A replacement item will be sent at no charge as quickly as possible.
- b. If a shipment is received by the customer with a line item missing they must notify Pulsafeeder Customer Service within 7 days of receipt of the product by the end user. If the customer had been billed for that item, a credit will be issued against the original Sales Order and a new Sales Order will be created for the replacement product.

#### 7. Damaged Items

- a. Should the customer receive an order that was damaged in transit, whoever paid the freight charges is responsible for filing the freight damage claim.
- b. Should the customer receive a product with damaged components due to improper packaging they should notify Pulsafeeder Customer Service within 7 days of receipt of product by end user. A replacement item will be sent at no charge as quickly as possible.

#### 8. Technical Support Services Available

- a. Pulsafeeder's Technical Sales Support team is available to provide all your sales and support needs. The principle mission of this group is to sell and support our customer base in a timely and effective manner. This includes the ability to provide in-field service training, assistance in start-up of our products and perform field repair of goods when required.

## Terms and Conditions

1. AGREEMENT. The contract of sale resulting from Seller's documentation together with these terms and conditions ("Contract") constitutes the entire agreement between the parties hereto, except as modified in writing signed by both the Seller and Purchaser. The Seller is Pulsafeeder, Inc. and the Purchaser is identified in the Contract. Any terms in a purchase order, irrespective of their materiality, which are either different from or additional to Seller's conditions of sale, are objected to and are excluded unless the Seller expressly agrees in writing to such terms. Execution of such forms by Seller to accommodate Purchaser's procurement or accounting procedures or to evidence agreed upon change orders shall not be construed as assent to Purchaser's terms. Acceptance of the goods shipped shall constitute assent to Seller's conditions of sale. This Contract shall be binding upon Purchaser and Seller, and on their successors and assigns.

2. PROPOSAL OR QUOTATION. A proposal shall not become binding upon Seller until it has been executed and returned by Purchaser. An oral quotation shall not be considered an offer: only a written confirmation thereof incorporating Seller's terms and conditions shall constitute an offer. All written quotations are valid for 30 days unless stated otherwise on the written quotation provided by Seller to Purchaser.

3. ORDER PLACEMENT. All orders shall be deemed accepted upon written acknowledgment from Seller and shall be subject to Pulsafeeder's terms and conditions in effect on the date the order is accepted. No additional different terms and conditions referred to or contained in any request for proposal, purchase order or other document from Purchaser shall apply. Any order cancellation or change is subject to a \$50.00 cancellation / change fee.

The minimum order amount is US \$30.00 based on Seller's list prices in effect at the time the order is received.

Orders requiring expedited shipping (sooner than the standard lead times) will be subject to a \$50.00 expedite charge.

Documents which require local Chamber of Commerce stamp and certification are subject to a \$50.00 per document fee.

Letters of Credit and Sight Draft's are subject to a \$1,000.00 fee.

All Credit card orders will be charged a \$50.00 transaction fee.

All orders must be submitted with correct pricing and shipping information. Orders submitted without correct pricing and shipping information may be rejected or delayed.

4. CREDIT. Credit terms of payment must have the approval of Seller's Credit Department and must be specified in writing on Seller's invoice or in the Contract. If Purchaser's credit is found by Seller to be unsatisfactory, Seller may rescind or terminate this Contract. If at any time during the term of this Contract Purchaser's financial responsibility becomes impaired or unsatisfactory to Seller, Seller reserves the right to stop shipment on notification to Purchaser, project owner and surety with a demand for payment in advance or at time of delivery for future deliveries or to require other security satisfactory to Seller and in the absence thereof, to cancel the unfilled portion of the Contract. Seller will notify Purchaser promptly of its decision to stop shipments and give an advance notice to the extent this is possible. In the absence of credit terms, sales are for cash.

5. PAYMENT. Specific terms of payment for this order shall be set forth on the reverse side of this Contract or identified and appended hereto. Purchaser agrees to make payment at Seller's location specified in this Contract in lawful money of the United States. Purchaser further agrees to make all payments when due to Seller in accordance with the agreed terms of payment in this Contract without reference to Purchaser's agreement with or payments by the owner and with no right of retention.

6. INTEREST AND COSTS. Purchaser agrees to pay interest at 1.5% per month (to the extent permitted by law) on all delinquent balances if and when assessed by Seller, and any attorney's fees or court costs arising out of and made necessary in collection of its obligation to Seller created by this Contract.

7. TAXES. Any federal, state or local tax assessment, fee, duty or charge hereafter imposed on or measured by the products purchased hereunder shall be for Purchaser's account unless Purchaser furnishes Seller an acceptable exemption certificate from such tax, fee, duty or charge prior to shipment.

8. FORCE MAJEURE. Seller shall make delivery in accordance with the terms of this Contract or within a reasonable time in the absence of any commitment, but Seller shall not be liable for delays or defaults in delivery caused by floods, fires, storms, or other acts of God, by war or act of public enemy (or civil disturbance), strikes, lock outs, shortages of labor or raw materials and supplies (including fuel) or production facilities, transportation service or equipment shortages or failures, action of any governmental authority or other conditions beyond Seller's reasonable control.

9. CANCELLATION. If Purchaser desires to cancel or change any portion of this Contract, Purchaser must make such request in writing to Seller. Seller may, in its sole discretion, accept or reject any such request. If accepted, the Purchaser nonetheless must take delivery and make payment to Seller for all material manufactured and in process of manufacture at time of notice, and all special materials ordered at time of notice and for which Seller must take delivery, unless otherwise agreed by Seller in writing. All such materials must be removed from Seller's premises within 30 days after payment and payment will be due at time of notice. Seller also reserves the right to make a cancellation charge in the event of cancellation by the Purchaser of an order placed in Seller's shipping schedule and acknowledged by Seller. Any order cancellation is subject to a \$50.00 cancellation fee.

10. INSPECTION AND TESTING. Seller's standard specifications and tests apply to all orders. All charges for inspections or tests not regularly furnished are for Purchaser's account and subject to prior negotiation. All inspections shall be conducted at Seller's plant, and failure of Purchaser to avail himself of inspection privileges shall be deemed a waiver of such privileges.

11. PRICES. Prices are subject to change without notice. Orders based on published prices and accepted for scheduled shipment will be invoiced at Seller's applicable price in effect on the scheduled date of shipment, unless otherwise specifically noted on the order acknowledgment. All prices will be in accordance with applicable government regulations. Orders specifying palletizing or special packaging will involve special charges.

12. DELAYS. All orders are accepted subject to Seller's ability to make delivery at the time and in the quantities specified, and Seller shall not be liable for damages for failure to make partial or complete shipment or for any delay in making shipments. Purchaser shall be liable for any added expenses incurred by Seller because of Purchaser's delay in furnishing requested information to Seller, delay resulting from order changes by Purchaser, or delay in unloading shipments at delivery point.

13 . SHIPMENT. Seller will select method of shipment and routing when transportation charges are for account of Seller. When shipping instructions are specified by the Purchaser, all costs will be for the account of the Purchaser. The foregoing includes, but is not limited to, carriers charges for notification prior to delivery, demurrage, delay in unloading, diversion, or reassignment. All shipments are Free Carrier (FCA) or EX Works (EXW) (Incoterms 2010) Seller's dock in Punta Gorda, Florida. Seller has the right to ship any order when it is complete or partially complete unless the order is marked do not ship before the request date.

All customer arranged freight (will advise) the Customer has 48 hours after Seller has advised them that the shipment is complete and ready for shipment. If the shipment has not left Seller within such 48 hour period the customer will be charged 1% of the shipment invoice value for each 24 hour period that the shipment remains at the Seller facility. Seller may also place the shipment in a public storage at Customer's expense and without liability to Seller.

Orders requiring expedited production (24-hour turnaround) and to be ready for shipment (Not including shipping) will be subject to a \$50 expedite charge.

Unless the order clearly requests expedited shipping, the order will be treated as a routine order. When expedited shipping is requested a designated carrier must be selected.

Pulsafeeder's hours of operations are 8am to 5pm eastern Monday – Friday. Orders that need to be ready for shipment 24 hours from receipt of order will be received during Pulsafeeder's hours of operation. Same day and next working day shipping is generally available for larger orders, please verify with customer service. Pulsafeeder shall have no liability if it is unable to provide expedited shipping of an order.

14 . TITLE. Title to products transfers to Purchaser upon Seller's delivery of the goods to the carrier for shipment. Purchaser is then responsible for proper protection of product, placement, compliance with all regulations and ordinances, and will indemnify Seller against all claims for personal injuries or property damage arising from the storage, use or handling of such products.

15 . IN TRANSIT CLAIMS. Claims for damage or shortage in transit must be made against the carrier by the owner of the shipment according to the FCA or EXW shipping terms as applicable. Purchaser has the responsibility to inspect shipments before or during unloading to identify any such damage or shortage and see that appropriate notation is made on the delivery tickets or an inspection report furnished by the local agent of the carrier in order to support a claim.

16 . CLAIMS. Notice of Claims against Seller hereunder for any reason, must be made to Seller in writing promptly after discovery and within any applicable warranty period. Failure to give such notice to Seller shall constitute a waiver by Purchaser of any right later to assert such a claim.

17 . RETURNS. Returned goods shall be accepted for credit only if in salable condition and only with evidence of Seller's prior written consent. Seller will assess charges for freight both ways and any costs necessary to restore such goods to the regular plant inventory . The amount of credit given will depend further up on the degree of saleability of products accepted in opinion of Seller.

18 . PATENTS. Seller agrees to defend, and to protect Purchaser against loss or damage arising out of any legal action for patent infringement in connection with the manufacture of its products sold to Purchaser, provided Seller is notified promptly of any such action with complete information and is given an opportunity to defend.

19 . WARRANTY; LIMITATION OF LIABILITY. Seller warrants title to each individual product sold under this Contract and further warrants for a period of twenty four (24) months from ship date, but only to the extent and limit of the purchase price paid for such individual product, that such product conforms to the specifications set forth in the Contract and is free from defects in material and workmanship under normal service and use for which it was designed. Seller's sole obligation and Purchaser's exclusive remedy under this warranty shall be limited to one of the following, as selected by Seller: delivering to Purchaser a replacement for any product or part thereof determined by Seller to be defective, repairing such product or part, or refunding the purchase price (or an equitable portion thereof) paid for such product or part by Purchaser. SELLER MAKES NO WARRANTY OF FITNESS OR MERCHANTABILITY, AND NO OTHER WARRANTY, WHETHER EXPRESS OR ARISING BY OPERATION OF LAW, COURSE OF DEALING, USAGE OF TRADE OR OTHERWISE IMPLIED SHALL EXIST IN CONNECTION WITH SELLER'S PRODUCTS OR ANY SALE OR USE THERE OF. Purchaser must notify Seller promptly and within the warranty period of any claim under this warranty. Seller's warranty extends only to the first purchaser of a product from Seller or Seller's authorized distributor. All goods not manufactured by Seller are warranted only to the extent of the warranties of the original manufacturer. Seller disclaims any liability arising from tort, including strict liability, and Seller further disclaims any liability (whether arising under this or any other provision of this Contract or otherwise) for any costs (including costs of removal or replacement), liabilities, lost profits, loss of good will or any other general, special, incidental or consequential damages incurred by Purchaser in connection with this Contract or any product purchased there under.

20 . LAW . This order shall be governed by and shall be construed by the law of the State of New York.

21 . GOVERNMENTAL REGULATIONS. Seller warrants that no code, law, regulation or ordinance of the United States, a state or any other governmental authority or agency or any applicable Executive Order has been violated in the manufacture or sale of the items covered by this Agreement and warrants that the equipment, supplies, and/or articles covered thereby conform with all such requirements.

22 . NUCLEAR FINANCIAL PROTECTION. Purchaser agrees to procure and maintain, as available to it, nuclear energy liability insurance, in a form of policy approved by the Nuclear Regulatory Commission, and protection, as available, against liability for nuclear incidents not covered by such insurance through an indemnity agreement, as provided in Section 170 of the Atomic Energy Act of 1954, as amended, or any succeeding comparable statutory provision, and the regulations there under. Such financial protection shall be effective prior to the time any equipment purchased from us is used or installed at or in connection with any nuclear facility and shall cover us an insured party . To the extent that such financial protection is not suitable to Purchaser. Purchaser agrees to use its best efforts to cause such financial protection to be obtained by eligible parties. We will cooperate with Purchaser and representatives of the nuclear energy insurance syndicates in complying with all underwriting requirements and with those insurance recommendations which may be mutually agreed up on. Notwithstanding any representations or warranties made by us elsewhere in these conditions of sale, we shall not be responsible for any bodily injury or property damage liability or any other public liability for any nuclear incidents, whether or not in respect of or arising in connection with use or installation of our equipment at any nuclear facility or in connection with any such facility. Purchaser hereby assumes any liability which might otherwise be imposed up on us and agrees to indemnify us and hold harmless from any such liability and costs or expenses in connection therewith.

** PULSAFEEDER®**

**27101 Airport Road  
Punta Gorda, FL 33982  
Phone: +1(941) 575-3800  
Fax: +1(941) 575-4085**

[www.pulsatron.com](http://www.pulsatron.com)



**An ISO 9001 Certified Company**

**PLM001 K18**

